

Multiband Combining System

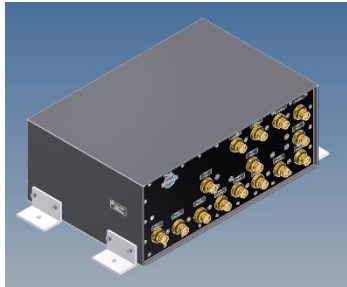

Not binding

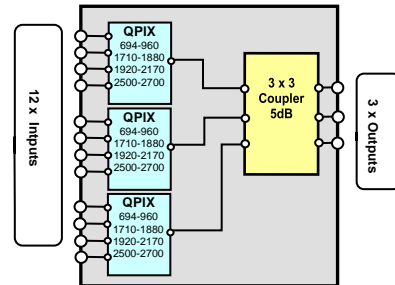

Block diagram

Part number	BN 572660
Input : output	12 : 3
Connectors	4.3-10 female (50 Ohms)
Frequency range	
Band 1	694 - 960 MHz (LTE700-GSM900)
Band 2	1710 - 1880 MHz (GSM1800)
Band 3	1920 - 2170 MHz (UMTS2100)
Band 4	2500 - 2690 MHz (LTE2600)
Insertion loss(* splitting losses)	
Band 1	≤ 0.4 dB +5.0 dB ± 1.2 dB*
Band 2	≤ 0.6 dB +5.0 dB ± 0.8 dB*
Band 3	≤ 0.7 dB +5.0 dB ± 0.8 dB*
Band 4	≤ 0.5 dB +5.0 dB ± 0.8 dB*
Isolation	
Interband	≥ 50 dB
Intraband	≥ 30 dB
VSWR	≤ 1.4 (typ. 1.25)
Power rating	125 W (CW) max. per port
IM-value	
3rd order @ 2 x 20 W	-155 dBc typical: ≤ -160 dBc
Degree of protection	IP65 (connectors facing downwards)
Environmental conditions	ETSI EN 300019-1-1 Class 1.2 ETSI EN 300019-1-2 Class 2.3 ETSI EN 300019-1-4 Class 4.1E
Temperature range	-40 °C – +65 °C
Weight	25 kg
Mounting	Universal mounting kit included

*unused input ports must be terminated with 5W standard load 531726 (to be ordered separately).

Dimensions (three different mounting options):

Option 1: Mounting angles used as feet

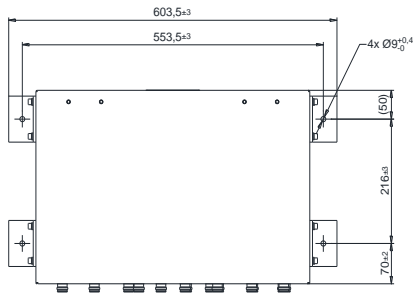
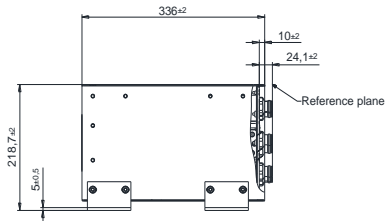
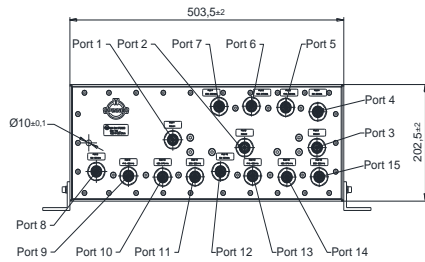

No.	In-/ Output	Band	MHz
Port 1	Output 1		
Port 2	Output 2		
Port 3	Output 3		
Port 4	Input	O1- LTE 700-GSM900	694 - 960 MHz
Port 5	Input	O1- GSM 1800	1710 - 1880 MHz
Port 6	Input	O1- UMTS2100	1920 - 2170 MHz
Port 7	Input	O1- LTE2600	2500 - 2690 MHz
Port 8	Input	O2- LTE 700-GSM900	694 - 960 MHz
Port 9	Input	O2- GSM 1800	1710 - 1880 MHz
Port 10	Input	O2- UMTS2100	1920 - 2170 MHz
Port 11	Input	O2- LTE2600	2500 - 2690 MHz
Port 12	Input	O3- LTE 700-GSM900	694 - 960 MHz
Port 13	Input	O3- GSM 1800	1710 - 1880 MHz
Port 14	Input	O3- UMTS2100	1920 - 2170 MHz
Port 15	Input	O3- LTE2600	2500 - 2690 MHz

Standard:
4,3-10 female (50 ohms): 62299

modifications reserved

Option 2: Connecting two stacked boxes

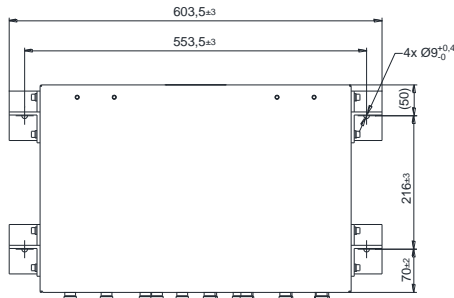
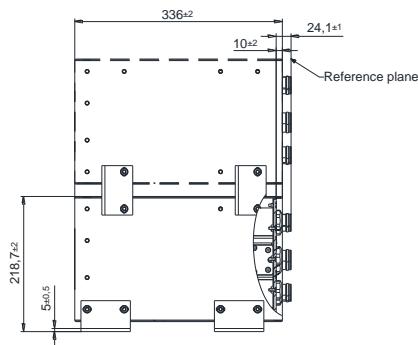
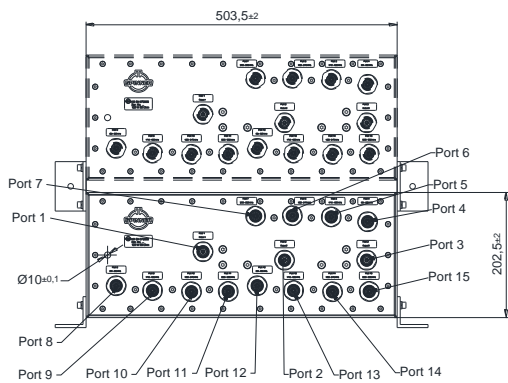

No.	In-/ Output	Band	MHz
Port 1	Output 1		
Port 2	Output 2		
Port 3	Output 3		
Port 4	Input	O1- LTE 700-GSM900	694 - 960 MHz
Port 5	Input	O1- GSM 1800	1710 - 1880 MHz
Port 6	Input	O1- UMTS2100	1920 - 2170 MHz
Port 7	Input	O1- LTE2600	2500 - 2690 MHz
Port 8	Input	O2- LTE 700-GSM900	694 - 960 MHz
Port 9	Input	O2- GSM 1800	1710 - 1880 MHz
Port 10	Input	O2- UMTS2100	1920 - 2170 MHz
Port 11	Input	O2- LTE2600	2500 - 2690 MHz
Port 12	Input	O3- LTE 700-GSM900	694 - 960 MHz
Port 13	Input	O3- GSM 1800	1710 - 1880 MHz
Port 14	Input	O3- UMTS2100	1920 - 2170 MHz
Port 15	Input	O3- LTE2600	2500 - 2690 MHz

Standard:
4,3-10 female (50 ohms): 62299

modifications reserved

Option 3: outdoor use (connector downward installation)

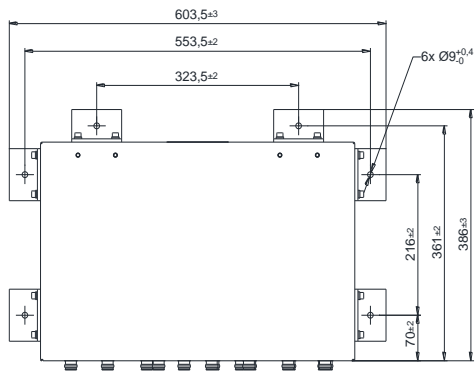
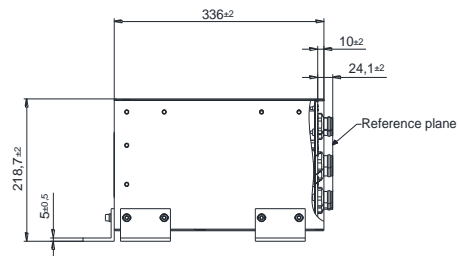
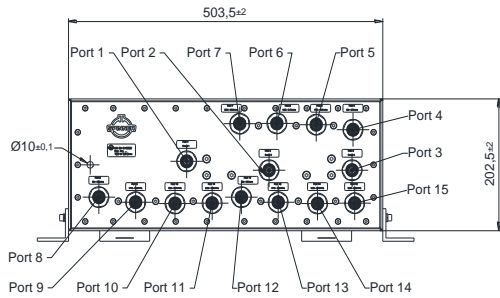

No.	In-/ Output	Band	MHz
Port 1	Output 1		
Port 2	Output 2		
Port 3	Output 3		
Port 4	Input	O1- LTE 700-GSM900	694 - 960 MHz
Port 5	Input	O1- GSM 1800	1710 - 1880 MHz
Port 6	Input	O1- UMTS2100	1920 - 2170 MHz
Port 7	Input	O1- LTE2600	2500 - 2690 MHz
Port 8	Input	O2- LTE 700-GSM900	694 - 960 MHz
Port 9	Input	O2- GSM 1800	1710 - 1880 MHz
Port 10	Input	O2- UMTS2100	1920 - 2170 MHz
Port 11	Input	O2- LTE2600	2500 - 2690 MHz
Port 12	Input	O3- LTE 700-GSM900	694 - 960 MHz
Port 13	Input	O3- GSM 1800	1710 - 1880 MHz
Port 14	Input	O3- UMTS2100	1920 - 2170 MHz
Port 15	Input	O3- LTE2600	2500 - 2690 MHz

Standard:

4,3-10 female (50 ohms): 62299

modifications reserved