

Cable Connector 6 1/8" EIA for Air Dielectric Cable 5" || BN 656780

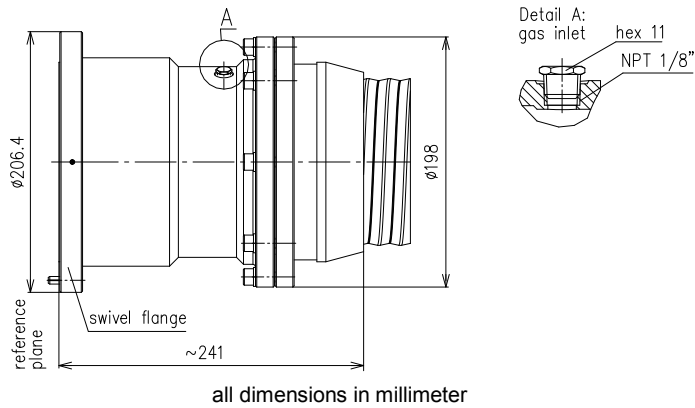

Interface type	6 1/8" EIA (50 ohms) per 339 IEC 50-155	
Frequency range	DC to 860 MHz	
VSWR, max.	1.02 @ DC to 860 MHz	
Peak power capability	1890 kW	
Average power capability	25.5 kW @ 860 MHz	
Proof voltage, max.	28 kV	
Inner conductor material / surface finish	copper alloy / silver plated	
Outer conductor material / surface finish	copper alloy / silver plated	
Other metal parts / surface finish	copper alloy / bright nickel plated stainless steel / untreated	
Insulation	PTFE	
Sealing	silicone rubber	
Degree of protection	IP 68 (pressure-tight up to 4 bar / 400 kPa)	
Cable compatibility	CommScope	HJ9-50
Handling instructions	M36249	
Weight, approx.	16.5 kg	
Operating temperature range	-40°C to +85°C	
Storage temperature range	-70°C to +85°C	
Gas inlet	NPT 1/8"	
Included in delivery	cover, sealing, installation instruction	