

Waveguide Pressure Window R 48 || BN 660762

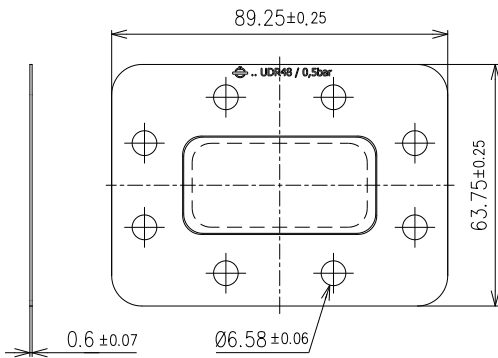

all dimensions in millimeter

Interface type	similar UDR 48 per IEC 60154-2
Frequency range	3.94 to 6.2 GHz
VSWR, max.	1.03
Material	copper alloy
Surface finish	untreated
Other parts	PI foil
Differential operating pressure, max.	0.05 MPa (0.5 bar), both-way
Weight, approx.	25 g