

Handling & Cleaning Instructions

DIAL GAUGE

BN 53 70 13 for testing mating face dimension N socket (50 Ω) according to IEC 61169-16

These instructions were written for qualified and experienced personnel. Please read them carefully before starting work. Any liability or warranty for the results of improper or unsafe use is disclaimed!

Range of application:

The dial gauge measures:

- Dimension "e" for general purpose connectors (green range)
- Dimension "e" for standard test connectors (yellow range)

gauged are:

- Dimension "b" for general purpose connectors and standard test connectors

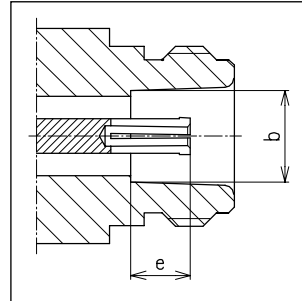

Handling:

Check with the reference gauge

This procedure must be executed prior to the test of every inspection lot. Do use the attached reference gauge only.

After insertion of the reference gauge the following scale positions must be indicated:

- Large pointer 0
- Small pointer green range
- Dimension 5.27 mm
- Large pointer $\neq 0$: untighten locking screw, turn bezel to position 0 and tighten locking screw hand-tight.

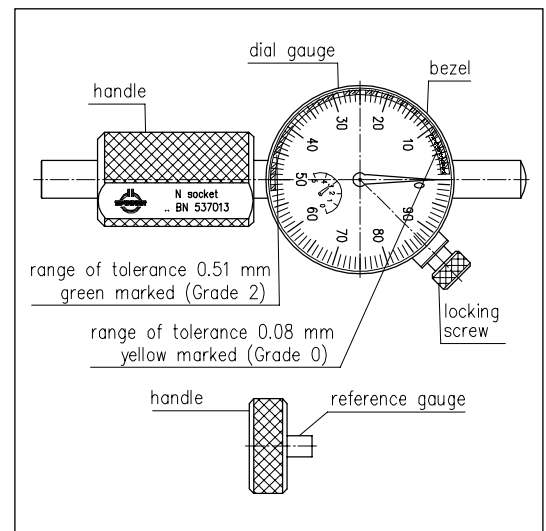

Note:

The dial gauge and reference gauge are precision measurement devices.

Therefore handle with care and consider as following:

- The connector interface must be neat and clean
- Hold dial gauge and reference gauge at the knurled handle only
- Measuring temperature: 23^{±5} °C
- Tighten locking-screw only by hand
- Small pointer adjusted only by factory
- Protect against humidity
- Prevent soiling
- Avoid shocks
- Do not lubricate
- A calibration is recommended at regular intervals.

The suggested initial interval for recalibration is 12 months. The actual need for recalibration depends on the use and the maintenance of the gauge. The recalibration interval should begin with the day of initial use.

Cleaning:

Dial gauge and connector interfaces, especially the outer conductor, should be kept clean and free of dirt and other debris.

Important tips:

- Use only denatured alcohol as a solvent.
- Use the proper size of cotton swab. Tweezers and a small piece of cotton can also be used.
- Only dampen the swab. Do **NOT** saturate it.

- Gently rotate the swab around the inner conductor being careful not to stress or bend the pin.
- Never put lateral pressure on the connector's inner conductor. The inner conductor does not require cleaning.
- Verify that no foreign material remains in the connector after cleaning.
- Verify that the inner conductor has not been bent or damaged.

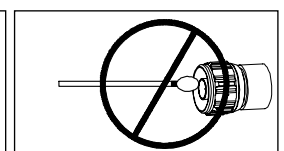
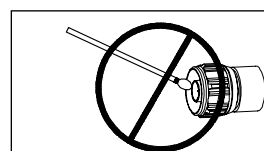
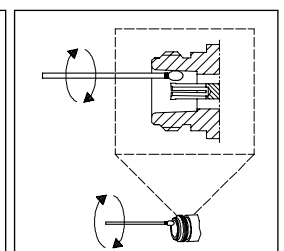
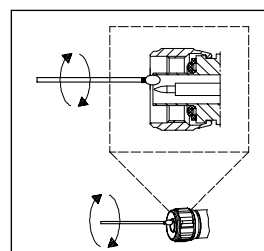
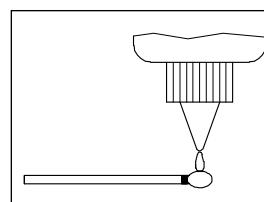

Note:

- Do **NOT** use other cleaning fluids nor solvents. Do **NOT** use water.
- Do **NOT** put cotton swabs in at an angle, or you will damage the connectors.
- Do **NOT** use too large of cotton swab, or you will damage the connectors.
- Standard cotton swabs are too large to fit in the smaller connector types. Appropriately sizes swabs can be purchased through a medical-lab-type supply center.