

Waveguide Pressure Window R 120 || BN 617642

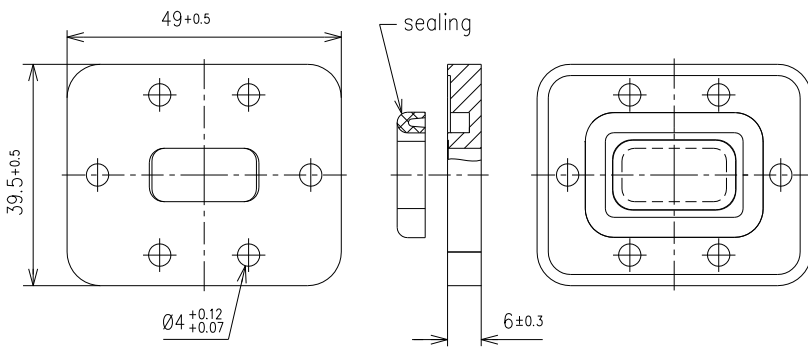

all dimensions in millimeter

Interface type	similar PDR/UDR per IEC 60154-2
Frequency range	9.8 to 15.0 GHz
VSWR, max.	1.04
Material / surface finish	copper alloy / no finish
Other metal parts / surface finish	PI foil / no finish
Sealing	silicone rubber
Differential operating pressure, max.	0.05 MPa (0.5 bar), both-way
Weight, approx.	75 g

SPINNER GmbH. This document is proprietary to us. All rights reserved. Any use, transfer, or reproduction of this document or the know-how contained therein requires our express consent.