

Attenuator 25 to 200 W



Type 25



Type 50



Type 100



Type 200

Attenuators are optionally also available with integrated DC-Break which have to be specified via Sales Article Numbers shown on last page. Frequency range and VSWR vary for these types and are shown in table below.

General technical data						
Frequency range, Attenuator	DC to 4 GHz (Extra feature: to 6 GHz)					
VSWR, max., Attenuator	1.06 @ DC to 1 GHz	1.14 @ 1 to 2 GHz	1.20 @ 2 to 3 GHz	1.30 @ 3 to 4 GHz	1.40 @ 4 to 6 GHz	
Frequency range, Attenuator + integrated DC-break	100 to 3800 MHz 5000 to 6000 MHz					
VSWR, max., Attenuator + integrated DC-break	1.70 @ 100 to 330 MHz	1.25 @ 330 to 694 MHz	1.20 @ 694 to 2690 MHz	1.30 @ 2690 to 3800 MHz	1.40 @ 5000 to 6000 MHz	
Attenuation						
DC to 4 GHz	3 ± 0.5 dB	6 ± 0.5 dB	10 ± 0.6 dB	20 ± 1.0 dB	30 ± 1.0 dB	40 ± 2.0 dB
4 to 6 GHz	3 ± 0.7 dB	6 ± 0.7 dB	10 ± 1.0 dB	20 ± 1.3 dB	30 ± 1.5 dB	40 ± 3.0 dB
Power						
Power dissipation, max.	Type 25	Type 50	Type 100	Type 200		
	25 W	50 W	100 W	200 W		
Input power, max., in both directions						
	@ 3 dB	@ 6 dB	@ 10 dB	@ 20 dB	@ 30 dB	@ 40 dB
Type 25	50 W	30 W	25 W	25 W	25 W	25 W
Type 50	100 W	65 W	50 W	50 W	50 W	50 W
Type 100	150 W	120 W	100 W	100 W	100 W	100 W
Type 200	300 W	200 W	200 W	200 W	200 W	200 W

Attenuator 25 to 200 W

IP protection level	IP50 per EN 60529 (Extra feature: IP68 per EN 60529)			
Weight, approx.	Type 25	Type 50	Type 100	Type 200
	0.6 kg	0.9 kg	1.1 kg	2.7 kg
Ambient temperature range	-40 to +40 °C full power 2) For higher ambient temperature see Power Derating Curve below			
Altitude, max.	2286 m full power 2)			
Operating position	any			
Power derating				

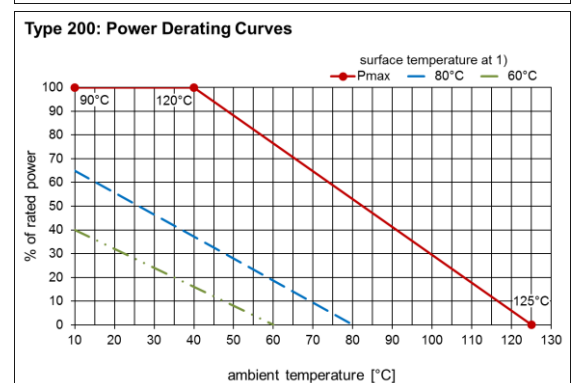
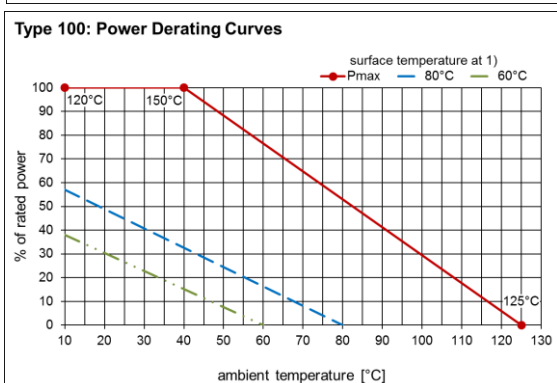
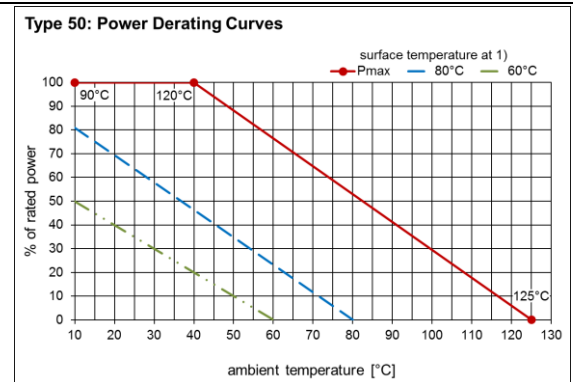
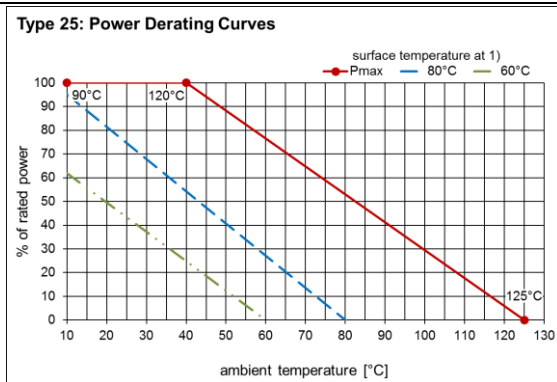

- 1) Measuring point for surface temperature, see graph
- 2) The maximum power handling is reduced with rising ambient temperatures, see Power Derating Curve

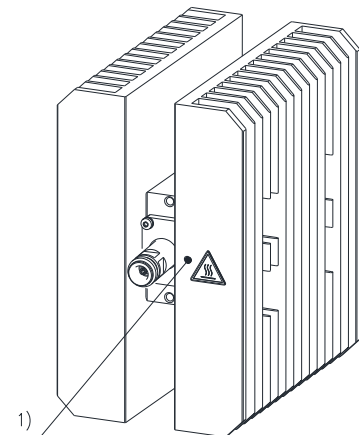
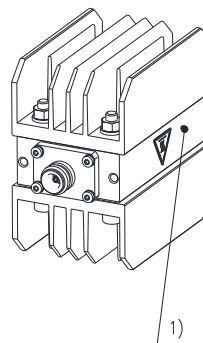
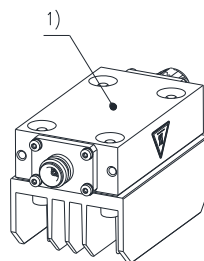
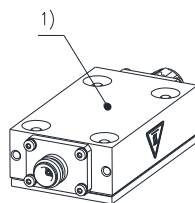

Attenuator 25 to 200 W

Dimensions and Variations:

Basic absorbing units

Type 25

Type 50

Type 100

Type 200

(All dimensions in millimeter)

Basic absorbing unit	
Substrate	aluminum nitride (free of beryllium oxide)
Case material / surface finish	aluminum / untreated
Heat sink	aluminum / anodised black
Other metal parts / surface finish	copper alloy / untreated stainless steel / untreated

Calculation of total length:
 Total length = length of body + length connector 1 + length connector 2
 Example on page 5

$$L_{Total} = L_{Body} + L_{C1} + L_{C2}$$

Attenuator 25 to 200 W

Connectors		
	male	female
N (50 Ω) per IEC61169-16	<p>Lc1,2 Type 25,50,100: 25.5 Lc1,2 Type 200: 40.6 Lc1,2 DC-Break: 40.6</p>	<p>Lc1,2 Type 25,50,100: 9.9 Lc1,2 Type 200: 34.6</p>
4.3-10 (50 Ω) per IEC 61169-54	<p>Lc1,2 Type 25,50,100: 13.0 Lc1,2 Type 200: 32.3</p>	<p>Lc1,2 Type 25,50,100: 21.0 Lc1,2 Type 200: 50.0 Lc1,2 DC-Break: 50.0</p>
7-16 (50 Ω) per IEC 61169-4	<p>Lc1,2 Type 25,50,100: 18.9 Lc1,2 Type 200: 35.9</p>	<p>Lc1,2 Type 25,50,100: 21.6 Lc1,2 Type 200: 45.6 Lc1,2 DC-Break: 45.6</p>

(All dimensions in millimeter)

Connectors	
Inner conductor material / surface finish	copper alloy / silver plated
Outer conductor material / surface finish	copper alloy / silver plated copper alloy / CuSnZn plated (4.3-10 Types)
Other metal parts / surface finish	copper alloy / bright nickel plated copper alloy / CuSnZn plated
Insulation	PTFE
Sealing	silicone rubber

Calculation of total length:

Total length = length of body + length connector 1 + length connector 2

$$L_{Total} = L_{Body} + L_{C1} + L_{C2}$$

Example on page 5

Attenuator 25 to 200 W

Sales article numbers

Attenuator	Power Dissipation	Connector 1	Connector 2	Attenuation	Extra Features	
A	X	Z	X	Z	-X	
25 W	25	Any combination of connectors below is possible				Leave blank if N/A
50 W	50					
100 W	100					
200 W	200					
7-16 male			7M			
7-16 female			7F			
4.3-10 male; screw			43MS			
4.3-10 male; hand screw			43MH			
4.3-10 male; push-pull			43MP			
4.3-10 female			43F			
N male			NM			
N female			NF			
3 dB				3		
6 dB				6		
10 dB				10		
20 dB				20		
30 dB				30		
40 dB				40		
Measurement protocol					P	
Extended frequency range					E	
DC break					D	
Upgrade from IP 50 to IP 68 (outdoor capable)					O	
Extended frequency range + measurement protocol					EP	
DC break + measurement protocol					DP	
Measurement protocol + IP 68					PO	
Extended frequency range + IP 68					EO	
DC break + IP 68					DO	
Extended frequency range + measurement protocol + IP 68					EPO	
DC break + measurement protocol + IP 68					DPO	

Examples:

A25-7M43MH-10 (Attenuator: Power Dissipation = 25 W; Connector 1 = 7-16 male; Connector 2 = 4.3-10 male hand screw; Attenuation = 10 dB)

Length calculation: $L_{Total} = 100 + 18.9 + 13.0 = 131.9$ mm

A200-NMNF-20-EP (Attenuator: Power Dissipation = 200 W; Connector 1 = N male; Connector 2 = N female; Attenuation = 20 dB; Extra Features: measurement protocol; extended frequency range DC to 6 GHz)

Length calculation: $L_{Total} = 100 + 40.6 + 34.6 = 175.2$ mm