

Coaxial Two Way Switch (DPDT) | BN 640081



Typical illustration

Radio frequency characteristics

Interface type (4 connections)	1 5/8" EIA (50 Ω) per IEC 60339-2 (threaded flanges)				
Characteristic impedance	50 Ω				
Frequency range	0 to 100 MHz	100 to 230 MHz	230 to 860 MHz	860 MHz to 1.6 GHz	1.6 to 2.0 GHz
VSWR, max.	1.03	1.03	1.05	1.08	1.08
Isolation, min.	80 dB	80 dB	80 dB	70 dB	60 dB
Insertion loss, max.	0.05 dB	0.05 dB	0.05 dB	0.10 dB	0.10 dB
Average power capability ^{RFC1)} at ambient temperature -10 to +45°C	19.0 kW	12.7 kW	6.6 kW	4.8 kW	4.3 kW
Peak voltage capability ^{RFC1)}	5.1 kV				

*RFC1) Standard conditions: - Dielectric: Dry air under standard pressure at sea level (p = 1013 hPa)
 - Load VSWR, max. 1.0 (no standing wave)
 - No modulation, sinusoidal carrier only*

Electrical and mechanical characteristics

Switch type	Two way switch, DPDT	
Actuator type	Motor drive, latching, self cutoff	
Connector J2 ^{EMC1)} for mains connection	5 pole SPINNER connector BN 126920, certified per VDE-Reg. No. B687, DIN EN 61984: 2009-11; EN 61984: 2009	
Mains connection	L, N, PE, TN-System	
Operating	Operating voltage	187 to 253 V AC 50/60 Hz
	Operating current, typ. ^{EMC2)}	0.5 A
	Nominal fuse	The switch must be secured externally by a time-delay fuse, 2 A
Connector J1 ^{EMC1)} for control, interlock contacts and signaling	25 pole connector per DIN 41652 / IEC 807-2	
Signal contacts Interlock contacts	Lead time typ. ^{EMC2)}	9 ms (the interlock/signal contacts open 9 ms before and close 9 ms after switching of the RF contacts)
	Maximum ratings	ES1 circuits per EN 62368-1, 42.4 V ACpk / 60 V DC / 0.5 A
	Current limiting	The circuit must be limited externally to 0.5 A

SPINNER GmbH
 This document is proprietary to us.
 All rights reserved. Any use, transfer, or reproduction of this document
 or the know-how contained therein requires our express consent.

Template 10014442.dotx



Coaxial Two Way Switch (DPDT) | BN 640081

Switching time, typ. ^{EMC2)}	0.12 s
Command hold time, min.	0.12 s (during this time, the voltage at control input must not change)
Switching frequency, max.	10 operations per minute
Life, min.	250,000 operations
Weight, approx.	5 kg

EMC1) Suitable mating connector included

EMC2) At room temperature and nominal voltage 230 V AC

Environmental conditions

Operational conditions	ETSI EN 300 019-1-3 V2.3.2 (2009-1) class 3.1 N
Ambient temperature ^{EC1)}	-10 to +60°C
Condensation	Not allowed
Relative humidity, max.	95%

The maximum input power can be applied up to 500 m or 1600 ft above sea level unless noted otherwise in the data sheet. Above this height the maximum input power must be reduced as shown in the diagram.

Derating of input power with increasing altitude

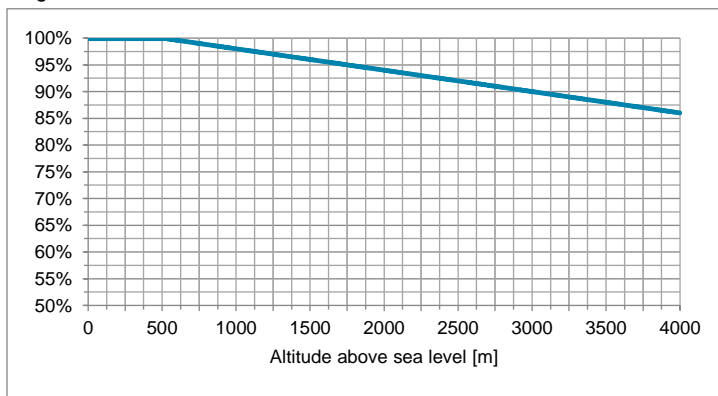

The maximum voltage can be applied up to 500 m or 1600 ft above sea level unless noted otherwise in the data sheet. Above this height the voltage must be reduced as shown in the diagram.

Derating of voltage with increasing altitude

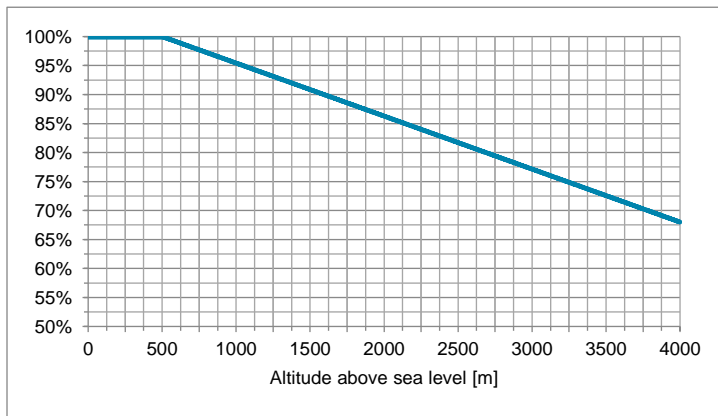

SPINNER GmbH
This document is proprietary to us.
All rights reserved. Any use, transfer, or reproduction of this document
or the know-how contained therein requires our express consent.

Template 10014442.dotx



Coaxial Two Way Switch (DPDT) | BN 640081

<p>Derating of input power with increasing ambient temperature</p>	<p>The maximum input power can be applied up to +45°C ambient temperature unless noted otherwise in the data sheet. Above this ambient temperature the maximum input power must be reduced as shown in the diagram.</p> <table border="1"> <caption>Derating of input power with increasing ambient temperature</caption> <thead> <tr> <th>Ambient temperature [°C]</th> <th>Input Power (%)</th> </tr> </thead> <tbody> <tr><td>-10</td><td>100</td></tr> <tr><td>0</td><td>100</td></tr> <tr><td>10</td><td>100</td></tr> <tr><td>20</td><td>100</td></tr> <tr><td>30</td><td>100</td></tr> <tr><td>40</td><td>100</td></tr> <tr><td>45</td><td>100</td></tr> <tr><td>50</td><td>92</td></tr> <tr><td>55</td><td>86</td></tr> <tr><td>60</td><td>82</td></tr> </tbody> </table>	Ambient temperature [°C]	Input Power (%)	-10	100	0	100	10	100	20	100	30	100	40	100	45	100	50	92	55	86	60	82
Ambient temperature [°C]	Input Power (%)																						
-10	100																						
0	100																						
10	100																						
20	100																						
30	100																						
40	100																						
45	100																						
50	92																						
55	86																						
60	82																						
<p>Max. altitude above sea level</p>	<p>4,000 m or 13,120 ft per IEC EN 60664-1</p>																						
<p>Protection class</p>	<p>I per IEC EN 61140</p>																						
<p>IP protection level</p>	<p>IP40 per IEC EN 60529 (all interfaces terminated)</p>																						
<p>Installation position</p>	<p>Any</p>																						
<p>Transport conditions</p>	<p>ETSI EN 300 019-1-2 V2.1.4 (2003-04) class 2.2</p>																						
<p>Ambient temperature</p>	<p>-25 to +70°C</p>																						
<p>Rain, condensation, icing</p>	<p>Not allowed</p>																						
<p>Storage conditions</p>	<p>ETSI EN 300 019-1-1 V2.1.4 (2003-04) class 1.2</p>																						
<p>Ambient temperature</p>	<p>-10 to +60°C</p>																						
<p>Rain, condensation, icing</p>	<p>Not allowed</p>																						

EC1) Extended temperature range on request

Applicable documents

<p>Product manual</p>	<p>M36023</p>
-----------------------	---------------

SPINNER GmbH
 This document is proprietary to us.
 All rights reserved. Any use, transfer, or reproduction of this document
 or the know-how contained therein requires our express consent.

Template 10014442.dotx

Coaxial Two Way Switch (DPDT) | BN 640081

Typical diagrams

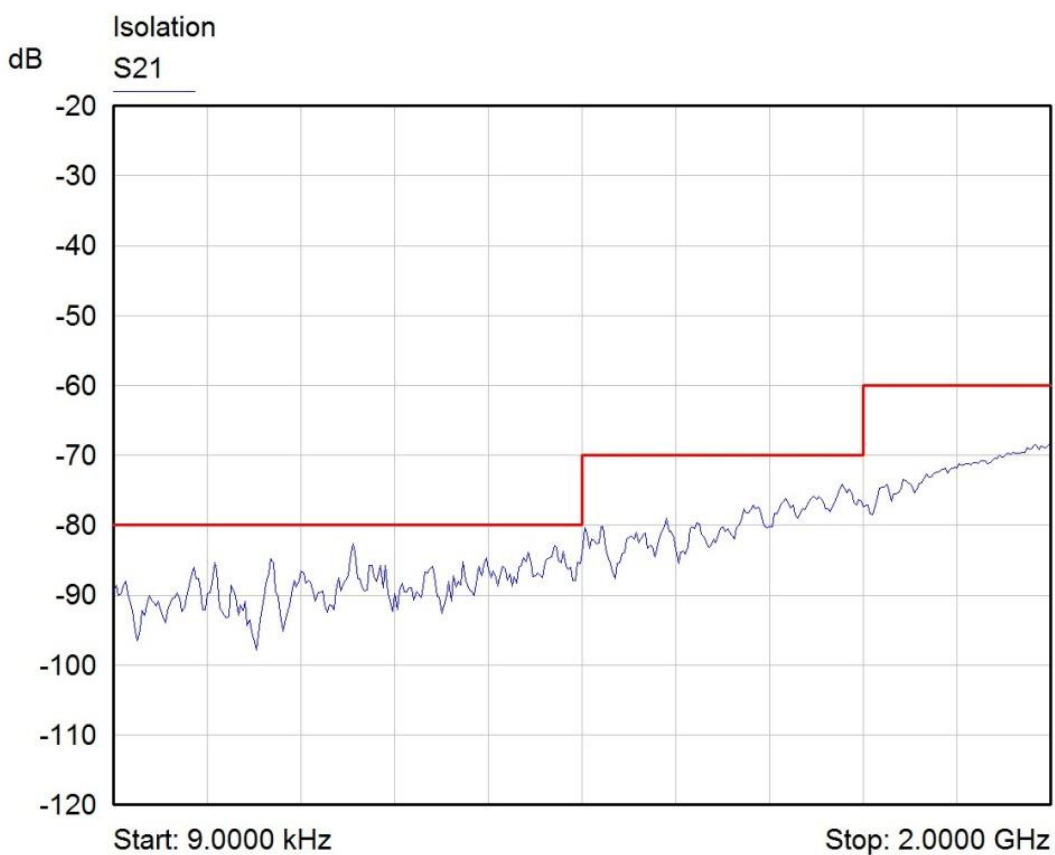
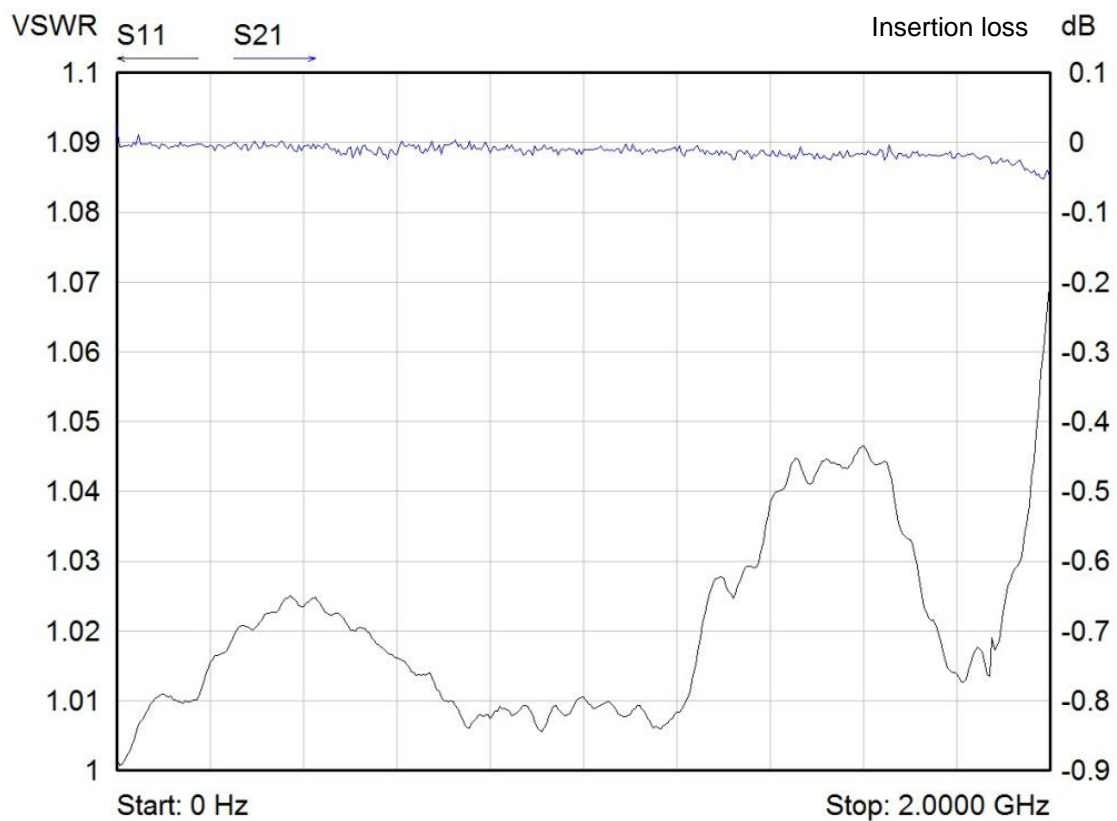

SPINNER GmbH
This document is proprietary to us.
All rights reserved. Any use, transfer, or reproduction of this document
or the know-how contained therein requires our express consent.

Template 10014442.dotx

Coaxial Two Way Switch (DPDT) | BN 640081

Circuit diagram

SPINNER GmbH
This document is proprietary to us.
All rights reserved. Any use, transfer, or reproduction of this document
or the know-how contained therein requires our express consent.

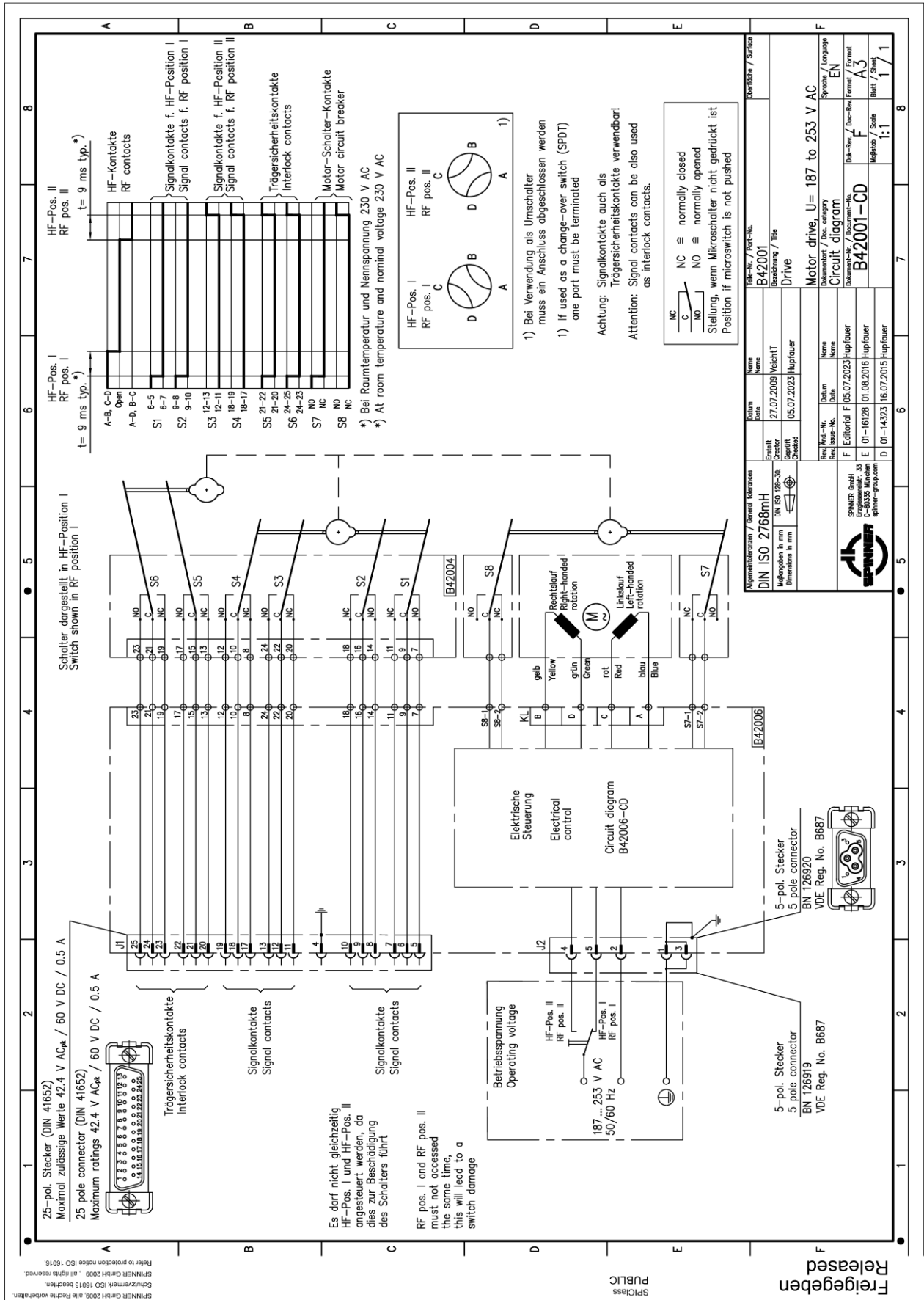

SPINNER GmbH 2009 alle Rechte vorbehalten.
Schutzvermerk ISO 15018 beachten.
SPINNER GmbH 2009, all rights reserved.
Refer to protection notice ISO 15018.

SPIClass PUBLIC

Freigegeben
Released

Coaxial Two Way Switch (DPDT) | BN 640081

Cable socket

© 1009 Spinner GmbH, Elektrotechnische Fabrik
 This drawing is a proprietary document.
 Any use, transfer or reproduction of this drawing or the
 know-how contained therein requires our express consent.

Anleitung für den Kabelanschluss Instructions for cable connection

1.
Entfernen des Schutzgehäuses
Removing of the protective housing

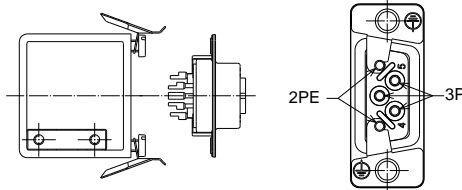

2.
Absetzen der Kabelitzen
Trimming of the cable strands



3.
3.a Anbringen der drei Schrumpfschläuche (PIN 2/4/5)
3.a Placing of the three heat shrinks (pins 2/4/5)
3.b Löten der fünf Kabellitzen
3.b Soldering of the five cable strands

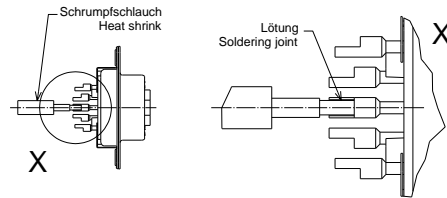

4.
4.a Aufschrumpfen der drei Schrumpfschläuche (PIN 2/4/5)
4.a Shrinking three heat shrinks (pins 2/4/5)
4.b Montage des Schutzgehäuses
4.b Assembling of the protective housing

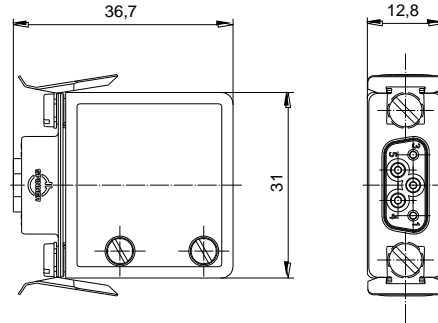
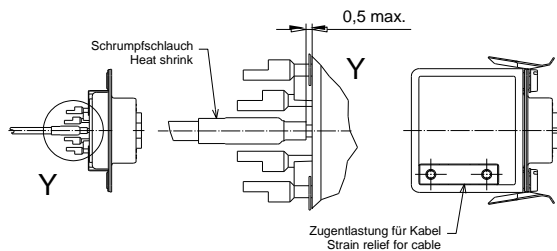

Technical data

5-polige Kabelkupplung 5 pole cable socket	ohne Schaltleistung Without breaking capacity
Bemessungsspannung Rated voltage	250 V AC
Bemessungsstrom Rated current	2 A
Bemessungsstoßspannung Rated impulse voltage	2.5 kV
Polzahl Number of poles	3P + 2PE
Anschlussart Kind of termination	Lötanschluss Solder termination
Leiterquerschnitt Cross section area	Max. 0.75 mm ² / min. 0.50 mm ²
Kabeldurchmesser Values for cable clamp	Ø 6 mm ... Ø 8 mm
Temperaturbereich Temperature range	-25 °C ... +85 °C
Steckzyklen Operation cycles	10
Schutzart Degree of protection	IP 20 nach / acc. to IEC EN 60529
Verschmutzungsgrad Degree of pollution	2
Max. Einsatzhöhe über N.N. Max. altitude above sea level	4000 m / 13,120 ft nach / acc. to IEC EN 60664-1
Schrumpfschlauch über Pins 2/4/5 Heat shrink above pins 2/4/5	
Zertifiziert nach Certified according to	VDE-Reg.-No. B687 DIN EN 61984: 2009-11; EN 61984: 2009
Zugelassene Steckerleiste Approved plug connector	BN 126920

**Beim Anschluss eines Kabels sind die gültigen Sicherheitsvorschriften zu beachten!
Please attend the valid safety rules for assembling!**

Konstruktionsänderungen vorbehalten
Design is subject to change without notice

Maßangaben in mm Dimensions in mm	Projektion E: Projection E:	Maßstab: / Scale:
Allgemeintoleranzen: General tolerances:	DIN ISO 2768mH	
Index: Revision:	Erstellt: Creator:	Bezeichnung: Title:
Art.-Nr.: Issue-No.:	31.01.2011	Kabelkupplung cable socket
Datum: Date:	Frank	5-polig / 5 pole, 250 VAC
Name: Name:	Geprüft: Checked:	
	12.12.2013	
D 01-1077203.12.2013	Hartmann	Zeichnungs-Nr.: Drawing-No.:
C 01-0907127.02.2013	Hupfauer	126919-0E
B DIV.CORR01.02.2011	Frank	Format: Format:
A Startindex31.01.2011	Frank	A4
		Blatt: Sheet: 1
		von: of: 1

Diese Zeichnung ist unser Eigentum. Verwendung, Vervielfältigung,
 Weitergabe der Zeichnungen oder des darin enthaltenen
 Know-hows an Dritte nur mit unserer ausdrücklichen Genehmigung.

SPINNER GmbH
 This document is proprietary to us.
 All rights reserved. Any use, transfer, or reproduction of this document
 or the know-how contained therein requires our express consent.



Spinner GmbH
Erzglössereistr. 33
D-80335 München