

Waveguide Pressure Window R 70 || BN 660664

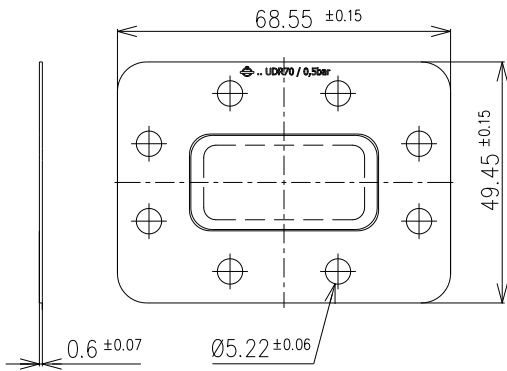

all dimensions in millimeter

Interface type	similar UDR 70 per IEC 60154-2
Frequency range	5.38 to 8.5 GHz
VSWR, max.	1.03
Material	copper alloy
Surface finish	untreated
Other parts	PI foil
Differential operating pressure, max.	0.05 MPa (0.5 bar), both-way
Weight, approx.	16 g