



# SPINNER || PRODUCT MANUAL

## **Coaxial two way switch (DPDT)**

RF interface 4 1/16"

BN 941934

BN 941934C0110

**High Frequency Performance Worldwide**

[www.spinner-group.com](http://www.spinner-group.com)

## Table of Contents

<b>1. Safety</b> .....	3
1.1 About this product documentation.....	3
1.2 Intended use .....	3
1.3 Improper use.....	3
1.4 Qualifications of personnel .....	3
1.5 Safety signs and symbols .....	4
1.6 Signal words for hazard seriousness.....	4
1.7 Grouped safety instructions for SPINNER broadcast products.....	5
<b>2. Function</b> .....	6
2.1 Motor drive.....	6
2.2 SPINNER hypocycloid drive .....	7
2.3 Bistable switching property (latching) .....	7
2.4 Manual override.....	7
2.5 Visual position indicator.....	7
2.6 Interlock / signal contacts .....	7
2.7 Earthing terminal.....	7
<b>3. Storage</b> .....	8
<b>4. Transportation</b> .....	8
<b>5. Installation</b> .....	8
5.1 Mechanical installation .....	9
5.2 RF installation.....	10
5.3 Electrical installation .....	10
<b>6. Commissioning</b> .....	11
<b>7. Operation</b> .....	11
<b>8. Cleaning</b> .....	12
<b>9. Maintenance</b> .....	12
<b>10. Repairs</b> .....	12
<b>11. Warranty</b> .....	12
<b>12. Demounting</b> .....	13
<b>13. Disposal</b> .....	14
<b>14. Additional hazard regardless to life cycle</b> .....	14
<b>15. Environmental friendly usage period</b> .....	14
<b>16. Spare parts</b> .....	15
<b>17. Accessories</b> .....	15
<b>18. Contacts</b> .....	15
<b>19. Attachments</b> .....	15

## 1. Safety

### 1.1 About this product documentation

The Spinner group makes every effort to keep the safety standard of our products up to date to be able to offer our customers the highest possible degree of safety. Our products are designed and tested in accordance with the relevant safety standards. There is, however, still a danger of personal injury or damage to equipment if this chapter and the safety instructions in this documentation are not complied with. This documentation aims at persons commissioned with the transport, installation, commissioning, operation, cleaning, demounting and disposal of SPINNER coaxial two way switches. Read this documentation completely and particularly the chapter 1. "Safety", before working with the product. Keep this product documentation available at the site and pass it on to the subsequent users. For all questions regarding the safety you can contact SPINNER at any time.

### 1.2 Intended use

Switching over (Double Pole Double Through or Single Pole Double Through) between two coaxial paths of an RF system in indoor applications on operating sites with limited access. Access for authorized persons shall be regulated by the operator. Details and other limits are given in the attached data sheet.

The intended use of the product is assumed, if it is used in accordance with the requirements of the applicable product documentation and within its performance limits (see attached data sheet, measurement protocols and the following safety instructions). Applicable local or national safety regulations and rules for the prevention of accidents must be observed in all work performed in conjunction with the product.

### 1.3 Improper use

The improper use of the product involves the use of the product:

- in operating rooms with unrestricted access
- in outdoor applications
- in explosion-prone atmosphere
- to support mechanical loads e.g. rigid lines or cables
- with modifications not authorized by SPINNER
- in damaged condition
- without correctly connected interlock system
- with interlock loop used for safety-related purposes
- in conditions and environments beyond the limits given in the attached data sheet

Any other use than described in the chapter intended use and in this product documentation is improper use and therefore inadmissible.

### 1.4 Qualifications of personnel













Installation, commissioning, operation and demounting of the product require electrical and mechanical specialized knowledge. In order to ensure the safe use, these activities may therefore only be carried out by qualified technical personnel or an instructed person under the direction and supervision of qualified personnel. Qualified personnel are those who, due to professional training, knowledge and experience as well as their understanding of the relevant regulations, are able to assess the work assigned, to recognize possible hazards and to institute appropriate safety measures.

Qualified personnel must have appropriate safety equipment and must be trained in first aid.

The use of the product requires special training and a high level of concentration. It must be ensured that persons who use the product are physically, mentally and emotionally able to comply with the requirements, otherwise injuries or material damage may occur. The employer or operator must choose suitable personnel for use of the product.

## 1.5 Safety signs and symbols

Safety signs are used on warning labels, stickers, in the product documentation and on the packaging of the product.

					
Warning! General hazard	Warning! Danger of electric shock	Warning! Hot surface	PE terminal	Earth	Warning! High weight
					
Warning! Non-ionised electromagnetic radiation	No access for persons with pacemakers	Use safety shoes	Use safety helmet	Use safety gloves	Observe product documentation

## 1.6 Signal words for hazard seriousness

Signal words are used on warning labels, stickers, in the product documentation, on specific danger spots and on the packaging of the product. They indicate the hazard seriousness in safety instructions.

- DANGER** Indicates a hazardous situation conveying great risk which, if not avoided, will result in death or serious injury.
- WARNING** Indicates a hazardous situation conveying moderate risk which, if not avoided, could result in death or serious injury.
- CAUTION** Indicates a hazardous situation conveying minor risk which, if not avoided, may result in minor or moderate injury.
- NOTICE** Indicates the possibility of faulty operation that can damage the product.

It is essential to make sure that the signal words described here are always used only in connection with the related product documentation and the related product. The use of signal words in connection with unrelated products or documentation can result in misinterpretation and thus contribute to personal injury or material damage.

## 1.7 Grouped safety instructions for SPINNER broadcast products

### Entire or multiple phases of product lifecycle

- Unless otherwise specified, these products are not protected against condensation, penetration of liquids, gases, steam, etc. Failure to comply could result in electric shock or product damage, which could also lead to serious injury.
- Blocking of constructive openings on the product (ventilation slots, fine leaks etc.) must be prevented, because these are necessary for product operation. Failure to comply could lead to overheating and could result in burns, fire and electric shock.
- Any object that is not designed to be placed in the openings of the housing must not be used for this purpose. Doing so can cause short circuits inside the product and could result in electric shock, fire or injury.
- Depending on the function, certain products such as RF radio equipment can produce an elevated level of electromagnetic radiation. Considering that unborn babies require increased protection, pregnant women must be protected by appropriate measures. Persons with pacemakers may also be exposed to risks from electromagnetic radiation. The employer/operator must evaluate workplaces where there is a special risk of exposure to radiation and, if necessary, take measures to avert the potential danger.
- As with all industrially manufactured goods, the use of substances that induce an allergic reaction (allergens) such as nickel cannot be generally excluded. If you develop an allergic reaction (such as a skin rash, frequent sneezing, red eyes or respiratory difficulties) when using a SPINNER product, consult a physician immediately to determine the cause and to prevent health problems or stress.
- Should a fire occur, the product may release hazardous substances (gases, fluids, etc.) that can cause health problems. Therefore, suitable measures must be taken, e.g. protective masks and protective clothing must be worn.

### Transport

- The product may be very heavy. In some cases, the user may require suitable lifting gear and means of transportation to avoid back or other physical injuries.
- If auxiliary objects e.g. lifting tools, trolleys, shelves are required, check their suitability before use. Failure to comply could result in death or serious injury.
- Transport the product only in the original packaging. Do not unpack until immediately prior to installation. Failure to comply could result in death or serious injury.

### Installation

- Do not place the product on heat-generating devices such as radiators or fan heaters. The ambient temperature must not exceed the maximum temperature specified in the product documentation or in the attached data sheet. Product overheating could result in burns, fire and electric shock.
- Do not place the product on surfaces, vehicles, cabinets or tables that for reasons of weight or stability are unsuitable for this purpose. Always follow the installation instructions of the manufacturer when installing the product and fastening it to objects or structures (e.g. walls and shelves). An installation that is not carried out as described in the product documentation could result in death or serious injury.
- Mains driven products must be operated only from a TN power distribution system. The operator is responsible for using an appropriate and sufficiently dimensioned AC power line. The AC power line must be externally fused according to the product documentation. Failure to comply could result in fire or electric shock.
- Operation of products with protection class I according to EN 61140 is permitted only with a mains cable with protective earth connection. The protective conductor continuity must be inspected by an electrically skilled person. Failure to comply could result in electric shock.
- All externally connected circuits for controlling, alerting and signalling have to be fed from SELV sources acc. to DIN EN 60950-1 only. The current in these circuits has to be externally limited by means of fuses to values indicated in the product documentation. Failure to comply could result in fire and electric shock.
- Dangerous voltage must not reach the product over the outer conductor/waveguide. Failure to comply could result in electric shock.
- If the product is equipped with a ground terminal connection (equipotential connection), the ground terminal must be connected sufficiently dimensioned to earth. Failure to comply could result in electric shock.

## Commissioning / Operation

- Products in operation may be hot. Touching them could result in burns.
- Before applying RF-power to the product, ensure proper connection and matching (load, line, etc.) of all RF-connectors. Ensure sufficient mechanical rigidity of the RF-connections. Failure to comply could result in serious injuries by non-ionised electromagnetic radiation.
- Operation of the product with a damaged cable is not permitted. All cables must be checked on a regular basis to ensure that they are in proper operating condition. By taking appropriate safety measures and carefully laying the power cable, ensure that the cable cannot be damaged and that no one can be hurt or suffer an electric shock by e.g. tripping over the cable.
- Front panels, lids and covers must not be removed during operation. Otherwise, live components can be accessible. This could result in electric shock, fire and serious injury.
- If the product is subjected to pressure, the locally and nationally applicable guidelines for pressure vessels must be applied. Failure to comply could result in death or serious injury.

## Cleaning

- Prior to cleaning, turn off all feeding transmitters and disconnect them from the power supply. Use a soft, lint-free, dry cloth for cleaning. Do not use chemical cleaners. Perform cleaning only after cooling-down. Failure to comply could result in electric shock and burns.

## Repair

- Troubleshooting and repairs should only be carried out by qualified technical personnel or an instructed person under the direction and supervision of qualified personnel (see chapter 1.4 "Qualifications of personnel"). Observe the safety instructions and in particular chapter 1. "Safety" of this product manual. Failure to comply could result in death or serious injury.
- Do not modify the product and use only spare parts tested and approved by SPINNER. Failure to comply could result in death or serious injury.

## Disposal

- The operator is responsible for disposing of the product according to national waste disposal regulations. Improper disassembly or disposal may be hazardous.
- If hazardous substances or operation materials are used for operation of the product, which must be periodically disposed of (e.g. coolant), these materials must be treated in accordance with the safety instructions of the hazardous substance or operating material manufacturer and the national waste disposal regulations. Also observe the relevant safety instructions in this product documentation. Failure to comply could result in serious injury and environmental damage.

## 2. Function

### 2.1 Motor drive

A capacitor motor with a supply voltage of 187 to 253 V AC 50/60 Hz or 95 to 140 V AC 50/60 Hz is used to actuate the RF switch via a special hypocycloid gear box developed by SPINNER. The drive control system enables remote switching by means of a control voltage in the range of 8 to 31 V DC.

Order number	Supply voltage
BN 941934	187 to 253 V AC 50/60 Hz
BN 941934C0110	95 to 140 V AC 50/60 Hz

## 2.2 SPINNER hypocycloid drive

To avoid contact bounce at fast switching time, the switch is equipped with a hypocycloid gear box. It effectuates a change of torque and angular speed during the switching process. At the beginning of the switching process, the hypocycloid gear box offers very high torque at low angular speed. With increasing rotation angle of the switch, the angular speed increases continuously, while the torque decreases. The behaviour reverses after passing the centre position of the switch, i.e. the angular speed decreases while the usable torque increases. The drive unit is mechanically interlocked at the end positions.

## 2.3 Bistable switching property (latching)

The RF switches show a bistable switching behaviour. Switching takes place from one stable state into another after applying the control voltage. For this reason, an impulse control signal is sufficient. The minimum impulse length has to correspond to the maximum switching time, refer to attached data sheet. After completion of the switching process, the control voltage is no longer necessary. If the switch is in an end position and the operating voltage fails, the switch remains in the end position. This also applies to resetting.

The RF switch remains in an undefined switching state, if the operating voltage fails during the switching process. After reapplying the operating voltage, the RF switch continues the switching process until it reaches the originally demanded end position.

## 2.4 Manual override

The switch position can be selected by the user manually with the manual override. Disconnect the RF switch from the mains before using the manual override to avoid injury or damage. The manual override is used exclusively for manual switching of the RF switch in the de-energized and load-free state. The RF switch is mechanically interlocked in the end position.

## 2.5 Visual position indicator

The RF switch features a visual position indicator on the drive unit (top side) and on the bottom of the RF switch (bottom side). The position indicators signal switched RF paths in the respective switch end positions.

## 2.6 Interlock / signal contacts



### WARNING

Do not use the interlock loop for personal protection.

### NOTICE

Switch off all transmitters before actuating the RF switch.

Do not use the interlock loop for operational switch-off of the transmitters.

Connect all transmitters to the interlock loop to avoid RF switch damage.

Hot switching is not permitted

The interlock and signal contacts open before and close after switching of the RF contacts. Therefore the signal contacts can also be used for interlock purposes.

The interlock and signal contacts comply with the requirements for SELV (DIN EN 60950-1).

The maximum permissible voltage is 42.4 V ACpk / 60 V DC. This applies to the loop voltage and the voltage between signal or interlock contacts and to the earthed casing.

The circuit must be externally limited to 0.5 A.

## 2.7 Earthing terminal

To ensure equipotential bonding with other plant components, connect the marked earthing terminal to the main earthing busbar with a copper lead (min 6 mm<sup>2</sup>).

### 3. Storage

Keep dry and avoid exposure to sudden temperature changes to prevent condensation. Environmental conditions for storage are given in the attached data sheet.

**NOTICE** Do not unpack or remove any connector transportation locks until immediately prior to installation.

### 4. Transportation



Before you start, ensure to read and understand the safety instructions and in particular chapter 1. "Safety" of this product manual. Observe the national safety and accident prevention regulations. Failure to comply could result in death or serious injury.



#### **WARNING**

Crushing hazard

Falling objects may cause death and serious injury.

Use only lifting and transportation gear approved for the weight given in the attached data sheet.



Observe the safety instructions of the selected lifting and transportation gear.

Secure the cardboard box against tipping or falling.

Do not stand under suspended loads.

Wear safety shoes.

#### **WARNING**

High weight

The RF switch can be heavy. Improper transport could result in back or other physical injuries.

Observe the weight given in the attached data sheet.

Use suitable lifting gear.

Distribute the weight among several people and observe the following load limits:

- 18 kg to 32 kg / minimum 2 people required
- over 32 kg to 55 kg / minimum 3 people required
- over 55 kg / do not transport with the help of people, use suitable lifting gear



#### **CAUTION**

Sharp edges

Sharp edges may cause cuts and needle stick injuries.

Use safety gloves and handle carefully.

**NOTICE** Do not unpack until immediately prior to installation.

### 5. Installation



Before you start, ensure to read and understand the safety instructions and in particular chapter 1. "Safety" of this product manual. Only electrically skilled persons may install SPINNER RF switches in accordance with the national safety and accident prevention regulations. Failure to comply could result in death or serious injury.

#### **WARNING**

Radio frequency hazard

Radio frequency power can cause burns, eye injuries and electric shock.

Before installation ensure to disconnect your entire system from the power supply. Utilize appropriate devices and methods to prevent accidental energizing.

Perform installation only by electrically skilled persons who have been trained for the installation and cabling of RF systems.







**WARNING**

Crushing and impact hazard

Falling objects may cause death and serious injury.

Use only lifting and transportation gear approved for the weight given in the attached data sheet.

Observe the safety instructions of the selected lifting and transportation gear.

Secure the RF switch against tipping or falling until it is securely bolted to the mounting rack.

Do not loosen or remove the lifting lugs.

Wear safety shoes.

If it is necessary to stand below the RF switch during installation, wear safety shoes and hardhat.



**WARNING**

High weight

The RF switch can be heavy. Improper transport could result in back or other physical injuries.

Observe the installation instructions and weight given in the attached system drawing.

Use suitable lifting gear and the lifting lugs of the RF switch only.

Distribute the weight among several people and observe the following load limits:

- > 18 kg to 32 kg / minimum 2 people required
- > over 32 kg to 55 kg / minimum 3 people required
- > over 55 kg / do not transport with the help of people, use suitable lifting gear



**WARNING**

Electric shock hazard

Electric shock can cause severe burns and fatal injuries.

Before you start ensure to disconnect your entire system from the power supply.

Utilize appropriate devices and methods to prevent accidental energizing.

Do not damage or modify cables and connectors.

The mains connector must be de-energized during plugging.

The RF switch is not equipped with separating equipment for safe disconnection from mains.

The user must provide external separation equipment.



**CAUTION**

Sharp edges

Sharp edges may cause cuts and needle stick injuries.

Use safety gloves and handle carefully.

**NOTICE**

The supplied packaging and all connector transportation locks are reusable and required for transportation. Do not damage or dispose of the packaging and the transportation locks.

**5.1 Mechanical installation**

Install the RF switch in indoor applications on operating sites with limited access only. Do not stress the connectors and the manual override.

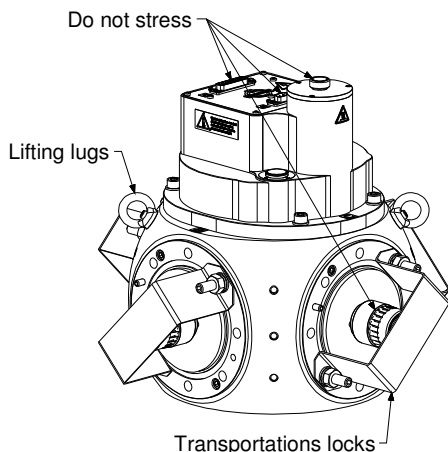

BN 941934

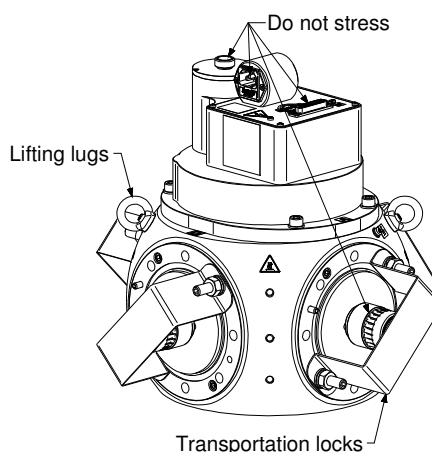

BN 941934C0110

Use the four fastening threads on the bottom of the switch to bolt it securely to the mounting rack. Use a torque wrench to tighten the bolted connections to 21.5 Nm (bolt material A2-50) or 46 Nm (bolt material A2-70).

**NOTICE** Do not clamp the RF switch on the casing.

## 5.2 RF installation

- Remove the connector transportation locks.
- Remove any dirt or metallic particles on contact surfaces before connecting.
- Align the system connectors carefully with the RF switch to avoid scratches on the contacts.
- Tighten the connectors with a torque wrench to 46 Nm, if the included fastening set with A2-70 bolts is used, or to 21.5 Nm, if A2-50 bolts are used.
- Ensure sufficient strength of all RF connections.
- Terminate unused ports by means of a suitable load.
- Relieve all RF connections from any bending torque, e.g. caused by heavy cables or assemblies. Avoid sharp bends and tensile load.

## 5.3 Electrical installation

**NOTICE** Switch off all transmitters before actuating the RF switch.

**NOTICE** Do not use the interlock loop for operational switch-off of the transmitters.

**NOTICE** Connect all transmitters to the interlock loop to avoid RF switch damage. Hot switching is not permitted.

- Follow the circuit diagram given in the attached data sheet and use the supplied connectors only to connect interlock, signal and mains.
- To ensure equipotential bonding with other plant components, connect the marked earthing terminal to the main earthing busbar with a copper lead (min 6 mm<sup>2</sup>).
- The interlock and signal contacts comply with the requirements for SELV (DIN EN 60950-1).
- The maximum permissible voltage is 42.4 V ACpk / 60 V DC. This applies to the loop voltage and the voltage between signal or interlock contacts and to the earthed casing. Limit the circuits externally by means of fuses to 0.5 A.
- Only BN 941934: Use a suitable and amply dimensioned power cord (min 0.5mm<sup>2</sup>, max 0.75mm<sup>2</sup>) and the supplied 5 pole cable connector BN 126919 only to connect power. For BN 126919 attachment follow the instructions given in the attached data sheet. Limit the power connection by means of an external fuse (time-delay, 2 A).
- Only BN 941934C0110: Use the supplied US power supply cord only to connect power.
- Relieve all connections to the RF switch from any bending torque, e.g. caused by heavy cables or assemblies. Avoid sharp bends and tensile load.
- The RF switch is not equipped with a power supply disconnecting device. The operator must provide external equipment for safe power supply disconnection.
- All connections to and from the product must be connected firmly. The connectors must not be dusty or dirty. Otherwise there is a risk of fire and injury. A deliberate interruption of the protective conductor connection in the AC line or in the product itself is not permitted. Otherwise there is a risk of electric shock. When extension cords are used, they must be adequately dimensioned and periodically inspected to ensure that they can be safely used.

## 6. Commissioning



Before you start, ensure to read and understand the safety instructions and in particular chapter 1. "Safety" of this product manual. Observe the national safety and accident prevention regulations. Failure to comply could result in death or serious injury. Only trained electricians should commission SPINNER RF switches.



### **WARNING**

Electric shock hazard

Electric shock can cause severe burns and fatal injuries.

Check proper connection and condition of all system connectors and cables prior to commissioning. The power connector must be de-energized during plugging.



### **WARNING**

Radio frequency hazard

Radio frequency power can cause burns, eye injuries and electric shock.

Check sufficient strength of all RF connections prior to commissioning.

Unused ports must be terminated.

Check proper functioning of the interlock loop prior to commissioning.

## 7. Operation



Before you start, ensure to read and understand the safety instructions and in particular chapter 1. "Safety" of this product manual. Only electrically skilled persons may operate SPINNER RF switches in accordance with the national safety and accident prevention regulations. Failure to comply could result in death or serious injury.



### **CAUTION**

Risk of burns, cuts and needle stick injuries

Touching the manual override during electrical switching may cause injuries.

Do not touch the manual override during electrical switching.



### **CAUTION**

Hot surface

The RF switch heats up during normal operation. Touching it may cause burns.

Do not touch the RF switch while hot. Wait until completely cooled off.

The operator must control the access to the hazardous area.

### **NOTICE**

Switch off all transmitters before actuating the RF switch to avoid RF switch damage. Hot switching is not permitted. Before applying RF power, ensure all RF switches are in their end position.

### **NOTICE**

Do not block the manual override during electrical switching to avoid overheating and RF switch damage. Disconnect the RF switch from the mains before using the manual override to avoid injury or damage. The manual override is used exclusively for manual switching of the RF switch in the de-energized and load-free state.

### **NOTICE**

Do not place any heat-generating devices such as radiators or fan heaters near to the RF switch to avoid overheating and RF switch damage.

### **NOTICE**

The control signals for RF position I and RF position II signals must not be applied simultaneously as this will damage the RF switch.

## 8. Cleaning



### WARNING

Electric shock hazard

Electric shock can cause severe burns and fatal injuries.

Before you start ensure to disconnect your entire system from the power supply.

Utilize appropriate devices and methods to prevent accidental energizing.

Do not use any cleaning fluid to avoid the risk of serious injury at re-commissioning.



### WARNING

Radio frequency hazard

Radio frequency power can cause burns, eye injuries and electric shock.

Do not loosen any RF connections or fastenings of RF lines.



### CAUTION

Hot surface

The RF switch heats up during normal operation. Touching it may cause burns.

Do not touch the RF switch while hot. Wait until completely cooled off.

Periodic cleaning of the mounted RF switch is not required. Use a soft, but not damp duster, if cleaning of the demounted RF switch is required. Do not use compressed air.

## 9. Maintenance

Periodic maintenance is not required. Carry out at least one switching cycle annually to avoid jamming. If the switch was not actuated for a period longer than one year (e.g. storage) carry out several switching cycles before applying RF power.

## 10. Repairs



### WARNING

Electric shock hazard

Electric shock can cause severe burns and fatal injuries.

Before you start ensure to disconnect your entire system from the power supply.

Do not open the RF switch to avoid the risk of electric shock and personal injury.



### CAUTION

Hot surface

The RF switch heats up during normal operation. Touching it may cause burns.

Do not touch the RF switch while hot. Wait until completely cooled off.

Troubleshooting and repairs must be only carried out by qualified technical personnel or an instructed person under the direction and supervision of qualified personnel (refer to chapter 1.4 "Qualifications of personnel"). The safety instructions and in particular chapter 1. "Safety" of this product manual must be observed.

## 11. Warranty

Do not disassemble the RF switch. The warranty is void, if the RF switch is modified, improperly handled or third party intervention or modification has occurred.

## 12. Demounting



Before you start, ensure to read and understand the safety instructions and in particular chapter 1. "Safety" of this product manual. Only electrically skilled persons may demount SPINNER RF switches in accordance with the national safety and accident prevention regulations. Failure to comply could result in death or serious injury.



### WARNING

Crushing and impact hazard

Falling objects may cause death and serious injury.

Use only lifting and transportation gear approved for the weight given in the attached data sheet.

Observe the safety instructions of the selected lifting and transportation gear.

Secure the RF switch against tipping or falling. Do not loosen or remove the lifting lugs.

Wear safety shoes.

If it is necessary to stand below the RF switch during installation, wear safety shoes and hardhat.



### WARNING

High weight

The RF switch can be heavy. Improper transport could result in back or other physical injuries.

Observe the installation instructions and weight given in the attached system drawing.

Use suitable lifting gear and the lifting lugs of the RF switch only.

Distribute the weight among several people and observe the following load limits:

- > 18 kg to 32 kg / minimum 2 people required
- > over 32 kg to 55 kg / minimum 3 people required
- > over 55 kg / do not transport with the help of people, use suitable lifting gear



### WARNING

Radio frequency hazard

Radio frequency power can cause burns, eye injuries and electric shock.

Before you start ensure to disconnect your entire system from the power supply.

Utilize appropriate devices and methods to prevent accidental energizing.

### WARNING

Electric shock hazard

Electric shock can cause severe burns and fatal injuries.

Before you start ensure to disconnect your entire system from the power supply.

Utilize appropriate devices and methods to prevent accidental energizing.

Unplug power and interlock connector in de-energized condition.



### CAUTION

Hot surface

The RF switch heats up during normal operation. Touching it may cause burns.

Do not touch the RF switch while hot. Wait until completely cooled off.



### CAUTION

Sharp edges

Sharp edges may cause cuts and needle stick injuries.

Use safety gloves and handle carefully.

### NOTICE

The supplied packaging and all connector transportation locks are reusable and required for transportation. If not available, contact SPINNER before starting demounting.

- Follow the procedure described in chapter 5 in reverse order. Do not stress the connectors and the manual override.

### 13. Disposal



**WARNING**

Risk of poisoning from decomposed PTFE  
 RF overload can lead to formation of decomposed PTFE.  
 Wear safety gloves and filtering facepiece (FFP2, EN149: 2001).  
 Do not burn PTFE to avoid toxic fumes.



**WARNING**

Crushing and impact hazard  
 Unsuitable or incorrect use of lifting gear could result in death or serious injury.  
 Use only suitable lifting and transportation gear for disassembly.  
 Observe the safety instructions of the selected lifting and transportation gear.  
 Do not stand under suspended loads.  
 Secure the RF switch against tipping or falling.  
 Wear safety shoes.

Observe the applicable national or local regulations when disposing of the product and the packaging.  
 The RF switch meets the requirements of RoHS and REACH (SVHC list based on the date of this document).  
 Forward these safety instructions to the disposer.

### 14. Additional hazard regardless to life cycle



**WARNING**

Lightning hazard  
 Lightning may cause electric shock, burns and serious injury.  
 Use suitable overvoltage protection to ensure that no overvoltage (such as that caused by a bolt of lightning) can reach the product. Use a copper lead (min 6 mm<sup>2</sup>) to connect the marked earthing terminal to the main earthing busbar.

### 15. Environmental friendly usage period



产品在正常使用条件下, 环保使用期限才在此标识有效期内。  
 The environmental protection use period is valid if the product is used as intended.

部件名称 Component name	有毒有害物质或元素 Toxic or hazardous substances and elements					
	铅 Pb	汞 Hg	镉 Cd	六价铬 Cr 6+	多溴联苯 PBB	多溴二噁醚 PBDE
金属零件 Metal parts	X	O	O	O	O	O

## 16. Spare parts

BN 941934:

Designation	Order-No.	Qty.
Mains cable connector (J2, 5 pole)	BN 126919	1
Interlock/signaling cable connector (J1, 25 pole)	BN 122886	1

BN 941934C0110:

Designation	Order-No.	Qty.
US power supply cord (J2)	BN A76250	1
Interlock/signaling cable connector (J1, 25 pole)	BN 122886	1

## 17. Accessories

Designation	Order-No.	Qty.
Installation kit for coaxial two way switch (DPDT) 4 1/16" (50 ohms) / 4 1/2" (50 ohms)	BN 941934C3000	1

## 18. Contacts

### SPINNER GmbH

#### Headquarters

Erzgiessereistr. 33

80335 München

Germany

tel.: +49 89 12601-0

fax: +49 89 12601-1292

info@spinner-group.com

www.spinner-group.com

### SPINNER Telecommunication

#### Devices Co., Ltd.

351 Lian Yang Road

Songjiang Industrial Zone

Shanghai

201613 P.R. China

tel.: +86 21 577 45377

fax: +86 21 577 40962

info-china@spinner-group.com

## 19. Attachments

- Data sheet 941934-BE
- Data sheet 941934C0110-BE