



SPINNER I Product Manual

Load 5 kW

RF Interface 1 5/8" EIA

BN 537757C4033



products.spinner-group.com

HIGH FREQUENCY PERFORMANCE WORLDWIDE

www.spinner-group.com



Content

1 Safety 3

1.1 About this product documentation 3

1.2 Intended use 3

1.3 Improper use 3

1.4 Qualifications of personnel 4

1.5 Safety signs and symbols 4

1.6 Signal words for hazard seriousness 5

1.7 Grouped safety messages for SPINNER broadcast products 5

2 Product identification 7

3 Function 7

3.1 General 7

3.2 Interlock loop 8

3.3 Operating and display elements 8

4 Transportation 9

5 Storage 9

6 Installation 10

6.1 Mechanical installation 10

6.2 Electrical installation 12

7 Commissioning and normal operation 13

8 Cleaning 13

9 Maintenance and Warranty 14

10 Repairs 14

11 Demounting 14

12 Disposal 14

13 Spare Parts 15

14 Contacts 15

1 Safety

1.1 About this product documentation

The Spinner group makes every effort to keep the safety standard of our products up to date to be able to offer our customers the highest possible degree of safety. Our products are designed and tested in accordance with the relevant safety standards. There is, however, still a danger of personal injury or damage to equipment if this chapter and the safety instructions in this documentation are not complied with. This documentation aims at persons commissioned with the transport, installation, commissioning, operation, cleaning, maintenance, repairs, demounting and disposal of SPINNER dummy loads. Read this documentation completely and particularly the chapter "Safety", before working with the product. Keep this product documentation available at the site and pass it on to the subsequent users. For all questions regarding the safety you can contact SPINNER at any time.

1.2 Intended use

The intended use of the product is to terminate RF high power coaxial transmission lines. The dummy load BN 537757C4033 is designed to absorb RF power of max. 5 kW in broadcast or industrial indoor applications in operating rooms with restricted access. Access for authorized persons shall be regulated by the operator. Details and other limits are given in the attached data sheet 10065317.

The intended use of the product is assumed, if it is used in accordance with the requirements of the applicable product documentation and within its performance limits (see appendices data sheet, circuit diagram, material data sheet of the SPINNER coolant and the following safety instructions). Applicable local or national safety regulations and rules for the prevention of accidents must be observed in all work performed in conjunction with the product.

1.3 Improper use

The improper use of the product involves the use of the product:

- in operating rooms with unrestricted access
- in outdoor applications
- in explosion-prone atmosphere
- for transporting people or loads
- without correctly connected interlock system
- with covered inlet or exhaust air openings
- with modifications not authorized by SPINNER
- in damaged condition
- for private purposes
- in conditions and environments beyond the limits given in this product documentation













Any other use than described in the chapter intended use and in this product documentation is improper use and therefore inadmissible.

1.4 Qualifications of personnel

Installation, commissioning, operation, maintenance, repairs and demounting of the product require electrical and mechanical specialized knowledge. In order to ensure the safe use, these activities may therefore only be carried out by qualified technical personnel or an instructed person under the direction and supervision of qualified personnel. Qualified personnel are those who, due to professional training, knowledge and experience as well as their understanding of the relevant regulations, are able to assess the work assigned, to recognize possible hazards and to institute appropriate safety measures. Qualified personnel must have appropriate safety equipment and must be trained in first aid. The use of the product requires special training and a high level of concentration. It must be ensured that persons who use the product are physically, mentally and emotionally able to comply with the requirements, otherwise injuries or material damage may occur. The employer or operator must choose suitable personnel for use of the product.

1.5 Safety signs and symbols

Safety signs are used on warning labels, stickers, in the product documentation and on the packaging of the product.

					
Warning! General hazard	Warning! Danger of electric shock	Warning! Hot surface	PE terminal	Earth	Warning! High weight
					
Warning! Non-ionised electromagnetic radiation	No access for persons with pacemakers	Use safety shoes	Use safety helmet	Use safety gloves	Observe product documentation

1.6 Signal words for hazard seriousness

Signal words are used on warning labels, stickers, in the product documentation, on specific danger spots and on the packaging of the product. They indicate the hazard seriousness in safety messages.

- DANGER** Indicates a hazardous situation conveying great risk which, if not avoided, will result in death or serious injury.
- WARNING** Indicates a hazardous situation conveying moderate risk which, if not avoided, could result in death or serious injury.
- CAUTION** Indicates a hazardous situation conveying minor risk which, if not avoided, may result in minor or moderate injury.
- NOTICE** Indicates the possibility of faulty operation that can damage the product.

It is essential to make sure that the signal words described here are always used only in connection with the related product documentation and the related product. The use of signal words in connection with unrelated products or documentation can result in misinterpretation and thus contribute to personal injury or material damage.

1.7 Grouped safety messages for SPINNER broadcast products

Entire or multiple phases of product lifecycle

- Unless otherwise specified, these products are not protected against penetration of liquids, gases, steam, etc. Failure to comply could result in electric shock or product damage, which could also lead to serious injury.
- Blocking of constructive openings on the product (ventilation slots, fine leaks etc.) must be prevented, because these are necessary for product operation. Failure to comply could lead to overheating and could result in burns, fire and electric shock.
- Any object that is not designed to be placed in the openings of the housing must not be used for this purpose. Doing so can cause short circuits inside the product and could result in electric shock, fire or injury.
- Depending on the function, certain products such as RF radio equipment can produce an elevated level of electromagnetic radiation. Considering that unborn babies require increased protection, pregnant women must be protected by appropriate measures. Persons with pacemakers may also be exposed to risks from electromagnetic radiation. The employer/operator must evaluate workplaces where there is a special risk of exposure to radiation and, if necessary, take measures to avert the potential danger.
- As with all industrially manufactured goods, the use of substances that induce an allergic reaction (allergens) such as nickel cannot be generally excluded. If you develop an allergic reaction (such as a skin rash, frequent sneezing, red eyes or respiratory difficulties) when using a SPINNER product, consult a physician immediately to determine the cause and to prevent health problems or stress.
- Should a fire occur, the product may release hazardous substances (gases, fluids, etc.) that can cause health problems. Therefore, suitable measures must be taken, e.g. protective masks and protective clothing must be worn.

Transport

- The product may be very heavy. In some cases, the user may require suitable lifting gear and means of transportation to avoid back or other physical injuries.
- Transport the product only in the original packaging. Do not unpack until immediately prior to installation. Failure to comply could result in death or serious injury.

Installation

- Do not place the product on heat-generating devices such as radiators or fan heaters. The ambient temperature must not exceed the maximum temperature specified in the product documentation or in the data sheet. Product overheating could result in burns, fire and electric shock.
- Do not place the product on surfaces, vehicles, cabinets or tables that for reasons of weight or stability are unsuitable for this purpose. Always follow the installation instructions of the manufacturer when installing the product and fastening it to objects or structures (e.g. walls and shelves). An installation that is not carried out as described in the product documentation could result in death or serious injury.
- Mains driven products must be operated only from a TN power distribution system. The operator is responsible for using an appropriate and sufficiently dimensioned AC power line. The AC power line must be externally fused according to the product documentation. Failure to comply could result in fire or electric shock.
- Operation of products with protection class I according to EN 61140 is permitted only with a mains cable with protective earth connection. The protective conductor continuity must be inspected by an electrically skilled person. Failure to comply could result in electric shock.
- All externally connected circuits for controlling, alerting and signalling have to be fed from ES1 type sources acc. to IEC 62368-1 only. The current in these circuits has to be externally limited by means of fuses to values indicated in the product documentation. Failure to comply could result in fire and electric shock.
- Dangerous voltage must not reach the product over the outer conductor/waveguide. Failure to comply could result in electric shock.
- If the product is equipped with a ground terminal connection (equipotential connection), the ground terminal must be connected sufficiently dimensioned to earth. Failure to comply could result in electric shock.

Commissioning / Operation

- Products in operation may be hot. Touching them could result in burns.
- Before applying RF-power to the product, ensure proper connection and matching (load, line, etc.) of all RF-connectors. Ensure sufficient mechanical rigidity of the RF-connections. Failure to comply could result in serious injuries by non-ionised electromagnetic radiation.
- Operation of the product with a damaged cable is not permitted. All cables must be checked on a regular basis to ensure that they are in proper operating condition. By taking appropriate safety measures and carefully laying the power cable, ensure that the cable cannot be damaged and that no one can be hurt or suffer an electric shock by e.g. tripping over the cable.
- Front panels, lids and covers must not be removed during operation. Otherwise, live components can be accessible. This could result in electric shock, fire and serious injury.
- If the product is subjected to pressure, the locally and nationally applicable guidelines for pressure vessels must be applied. Failure to comply could result in death or serious injury.

Cleaning

- Prior to cleaning, turn off all feeding transmitters and disconnect them from the power supply. Use a soft, lint-free, dry cloth for cleaning. Do not use chemical cleaners. Perform cleaning only after cooling-down. Failure to comply could result in electric shock and burns.

Repair

- Troubleshooting and repairs should only be carried out by qualified technical personnel or an instructed person under the direction and supervision of qualified personnel (see chapter 1.4 "Qualifications of personnel"). Observe the section safety messages and in particular chapter 1 "Safety" of this product manual. Failure to comply could result in death or serious injury.
- Do not modify the product and use only spare parts tested and approved by SPINNER. Failure to comply could result in death or serious injury.

Disposal

- The operator is responsible for disposing of the product according to national waste disposal regulations. Improper disassembly or disposal may be hazardous.
- If hazardous substances or operation materials are used for operation of the product, which must be periodically disposed of (e.g. coolant), these materials must be treated in accordance with the safety instructions of the hazardous substance or operating material manufacturer and the national waste disposal regulations. Also observe the relevant safety instructions in this product documentation. Failure to comply could result in serious injury and environmental damage.

2 Product identification

The SPINNER dummy load BN 537757C4033 has a type plate.

It is containing the following information for product identification:



3 Function

3.1 General

The dummy load absorbs the RF power, converts it into heat and dissipates the heat to the surrounding area. If the temperature of the dummy load exceeds 65 ± 5 °C, a forced air cooling system consisting of six ventilators is activated by means of a temperature switch. Utilizing planar technology and an optimized shape of the resistor element, the dummy load ensures very low VSWR virtually independent of the RF power load.

3.2 Interlock loop

The internal 4 interlock loops for protection of the dummy load consists of the interlock switches in mains monitoring relay and the interlock switches in the temperature controller. In principle each interlock loop works like three in series connected switches which are all closed during normal operation of the dummy load. Any open switch shuts down all transmitters connected to the corresponding interlock loop.

The internal interlock loops comply with the requirements for Electrical energy Source class 1 (ES1 type according to IEC 62368-1, safe separation, proof voltage resistance 4 kV ACpk to primary circuit).

The maximum permissible voltage for the interlock loop and to the grounded housing is 42.4 V ACpk respectively 60 V DC. The power supply must be fully compliant with the ES1 type requirements. The circuit has to be limited externally to 1 A.

NOTICE To avoid overheating caused by RF overload ensure to connect all relevant transmitters to the interlock system of the dummy load prior to commissioning.

Schematic diagram of the switching status during normal operation:

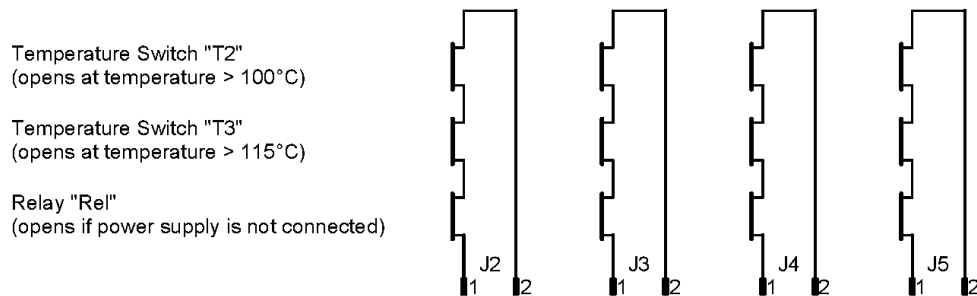

3.3 Operating and display elements

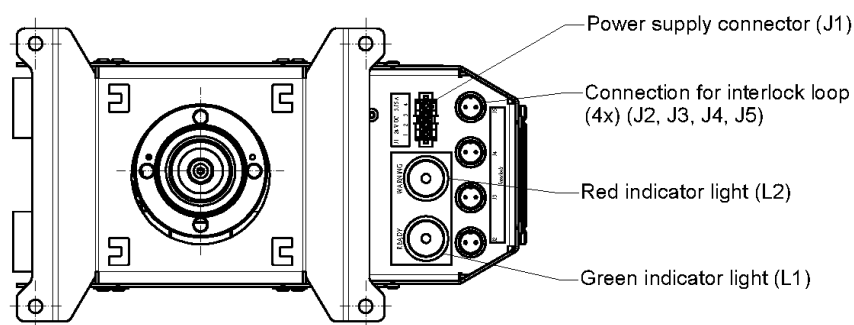

Green indicator light "READY":

The green light indicates readiness for operation:

- Mains voltage is connected
- No fault occurred

Red indicator light "WARNING":

The red light indicates that the interlock loop of the load is interrupted. All transmitters connected properly to the interlock loop are turned off.

The red indicator lamp lights, if the mains voltage is connected and the following condition is true:

- Resistor element temperature too high

4 Transportation



WARNING

Risk of falling objects and crushing hazard



The dummy load is heavy. Crushing or falling may cause injuries.

Use suitable means of transportation approved to carry at least 32 kg. Secure the dummy load temporarily with fixing straps against dropping, toppling or shifting until it fastened securely with suitable screws to the floor or wall of the installation site.



Safety shoes are required. If it is necessary to stand below the dummy load during installation, a safety helmet is also required.

NOTICE The dummy load is sensitive to impact and vibration; do not drop.

NOTICE Do not expose the dummy load to rain, snow and temperatures deviating from the storage temperature range.

NOTICE Do not remove any connector protection caps until immediately prior to installation to avoid formation of dust and scratches on sensitive contact surfaces.

NOTICE Do not lift the dummy load at the RF connector.

Environmental conditions for transportation see attached data sheet TD-00060.

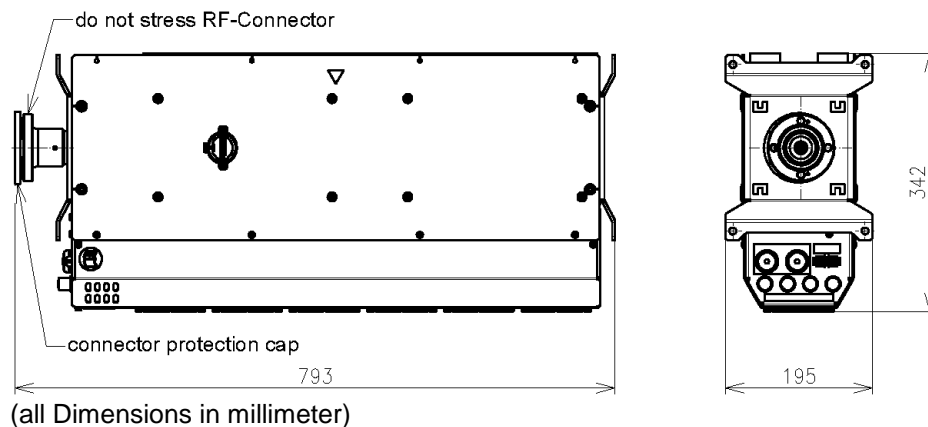

5 Storage

NOTICE Do not remove any connector protection caps until immediately prior to installation to avoid formation of dust and scratches on sensitive RF contact surfaces.

Keep dry and avoid exposure to sudden temperature changes to prevent condensation. Environmental conditions for storage are specified in the attached data sheet 10065317. Do not unpack until immediately prior to installation.

6 Installation



Before you start, ensure to read and understand the section safety messages and in particular chapter 1 "Safety" of this product manual. Only electrically skilled persons should install SPINNER dummy loads in accordance with the national safety and accident prevention regulations.

Failure to observe could result in death or serious injury.

6.1 Mechanical installation



WARNING

Crushing Hazard

Falling objects may cause death and serious injury.



The dummy load is heavy. Use suitable lifting gear only. The lifting gear must be approved to carry at least 32 kg.

Do not lift the dummy load at the RF connector.



Do not stress the expense vessel and the emergency stop.

Use suitable fasteners if mounted in an elevated position.

Safety shoes are required. If it is necessary to stand below the dummy load during installation, safety shoes and hardhat are required.

WARNING

Electric shock hazard

Electric shock can cause severe burns and fatal injuries.



Do not install and operate the dummy load in environmental conditions beyond the specifications given in the attached data sheet 10065317. The dummy load is designed for indoor application on operating sites with limited access only.

The dummy load must be installed on a flat and solid ground with bearing capacity higher than 32 kg to ensure stability. The connector panel needs to be easily accessible. Do not install the dummy load on escape routes, corridors or near temperature sensitive equipment. The required floor space for best possible cooling capacity is specified in the installation drawing below. Do not install the dummy load in small rooms or closets. Ensure unobstructed air circulation to avoid overheating. The dummy load can be installed horizontal or vertical, as shown below. Use the supplied screw set to mount the fastening angles on the dummy load. Fasten the dummy load with suitable screws securely to the floor or wall.

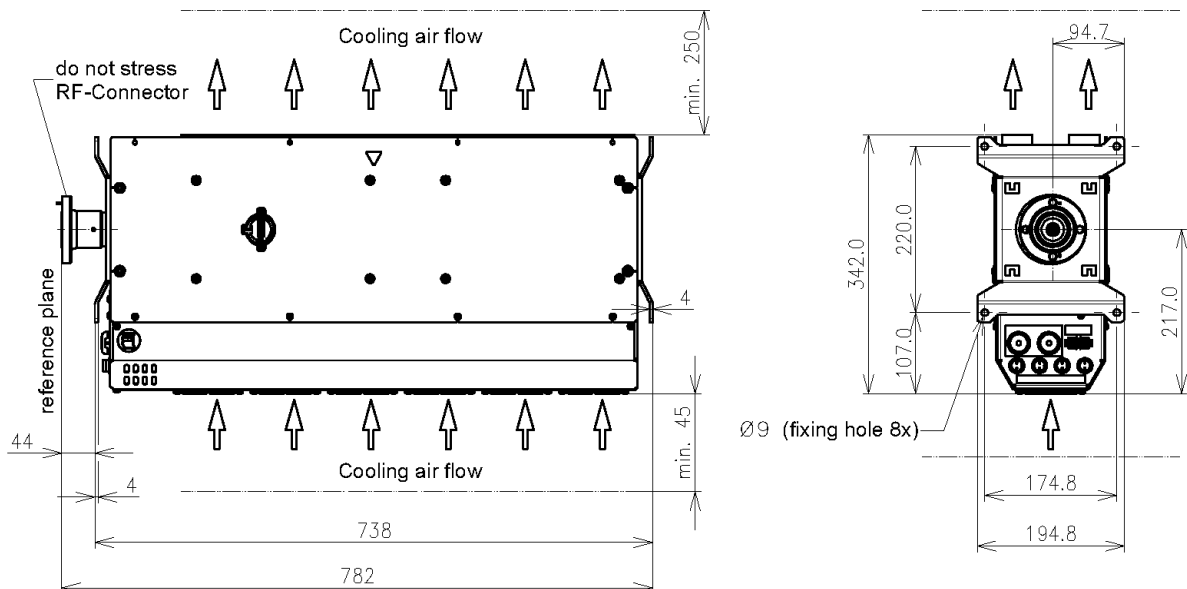

4x Fastening angle with screw set (4x screw M8x20, 8x washer, 4x hex nut) included in delivery

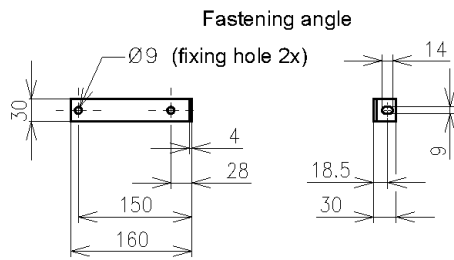

(all Dimensions in millimeter)

All mounting positions except with air flow downwards are allowed.

Examples:

e.g. horizontal installation, cooling air flow horizontal

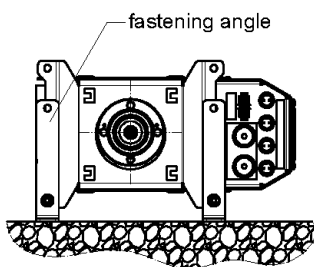

e.g. horizontal installation, cooling air flow upwards

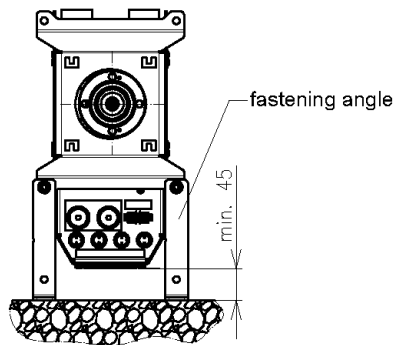

not allowed
cooling air flow downwards

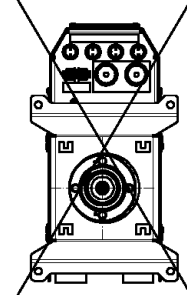

e.g. upright installation

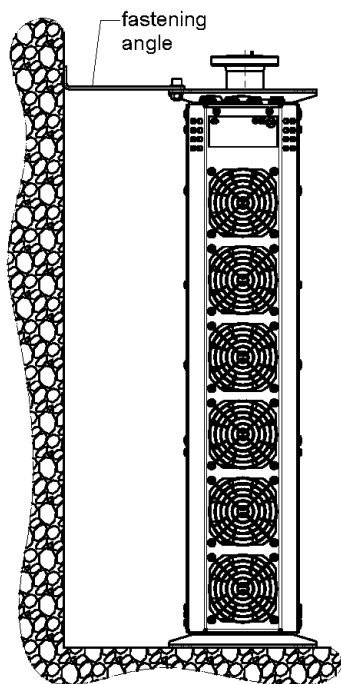

e.g. hanging installation

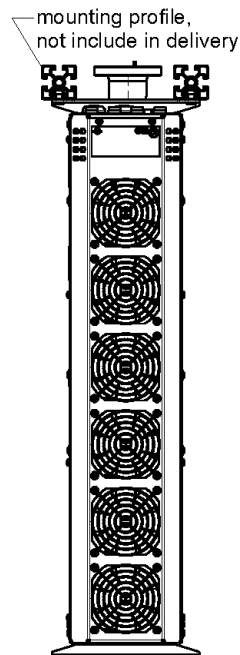

(all Dimensions in millimeter)

6.2 Electrical installation



Before you start, ensure to read and understand the Basic Safety Instructions and the additional safety instructions on personal safety that appear in relevant parts of this manual. Failure to observe could result in death or serious injury. Only electrically skilled persons may install SPINNER dummy loads in accordance with the national safety and accident prevention regulations

WARNING

Electric shock hazard



Electric shock can cause severe burns and fatal injuries.

Before you start ensure to disconnect your entire system from the power supply.

Utilize appropriate devices and methods to prevent accidental energizing. The dummy load is not equipped with separating equipment for safe disconnection from mains.

Unplug the power cord for safe disconnection from mains.

WARNING

Electric shock hazard



Improper wiring can cause electric shock, severe burns and fatal injuries.

Do not use the interlock loop for personal protection.

WARNING

Radio Frequency Hazard



Radio Frequency Power can cause burns, eye injuries and electrical shock.

Before connecting the RF cable, ensure to disconnect your entire system from the power supply. Utilize appropriate devices and methods to prevent accidental energizing.

Check proper connection of all RF connectors prior to commissioning.

Follow the attached circuit diagram 10045321 and the installation order given below:

- Mount the supplied interlock loop connector on a suitable cable and attach the connector to the dummy load according to the attached circuit diagram 10045321. Check proper function of the interlock system prior to commissioning. Do not use the interlock loop for personal protection.
The maximum permissible voltage for the interlock loop and to the grounded housing is 42.4 V ACpk respectively 60 V DC. The power supply must be fully compliant with the ES1 type requirements according to IEC 62368-1. The circuit has to be limited externally to 1 A. Check proper function of the interlock system prior to commissioning.
- Connect the mains adaptor 24 V DC to the connector (J1). Use an easily accessible socket located close to the dummy load for mains connection. Connect the mains adaptor only to TN networks (L, N, PE) 90 to 264 V AC, 47 to 63 Hz.
- Connect the RF cable. Use RF connectors according to IEC 339 only.
- Relieve all connections to the dummy load from any bending torque, e.g. caused by heavy cables or assemblies.

7 Commissioning and normal operation



Before you start, ensure to read and understand the Basic Safety Instructions and the additional safety instructions on personal safety that appear in relevant parts of this manual. Failure to observe could result in death or serious injury. Only electrically skilled persons may commission and operate SPINNER dummy loads



WARNING

Electric shock hazard

Electric shock can cause severe burns and fatal injuries.

Check safety of the electrical installation prior to commissioning.

Check proper function of the dummy load after commissioning.



WARNING

Radio Frequency Hazard

Radio Frequency Power can cause burns, eye injuries and electrical shock

Utilize appropriate devices and methods to prevent accidental energizing.

Check proper connection of all RF connectors prior to commissioning.



CAUTION

Hot surface

The dummy load heats up during operation and may cause burns.

The surfaces can reach temperatures up to 115 °C. Precautions must be taken to avoid touching the hot dummy load. Touch only when cooled down.

NOTICE To avoid overheating caused by RF overload ensure to connect all relevant transmitters to the interlock loop of the dummy load.

NOTICE Do not cover the venting openings or place objects on the heat exchanger.

NOTICE Check proper connection of all system connectors prior to commissioning.

NOTICE Ensure the green mains signalization is lit before applying RF.

8 Cleaning



Electric shock hazard

Electric shock can cause severe burns and fatal injuries.

Before you start ensure to disconnect the mains adapter from the power supply.

Utilize appropriate devices and methods to prevent accidental energizing.

Do not use any liquids for cleaning to avoid the risk of electric shock at recommissioning.



CAUTION

Hot surface

The dummy load heats up during operation and may cause burns.

The surfaces can reach temperatures up to 115 °C. Precautions must be taken to avoid touching the hot dummy load. Touch only when cooled down.

Use a soft, but not damp duster, if cleaning of the dummy load is required. Check the heat exchanger at least every 6 months and remove dust or dirt with compressed air or a soft synthetic brush.

9 Maintenance and Warranty

The dummy load does not require any maintenance. Do not disassemble the dummy load. The warranty is void, if the dummy load is modified, improperly handled or third party intervention or modification has occurred.



Do not open the case or the mains adapter to avoid possible electric shock, high frequency radiation and the risk of serious injury.

10 Repairs

Repairs may only be executed by the manufacturer.



WARNING

Do not open the case or the mains adapter to avoid possible electric shock, high frequency radiation and the risk of serious injury.



CAUTION

Hot surface

The dummy load heats up during operation and may cause burns.

The surfaces can reach temperatures up to 115 °C. Precautions must be taken to avoid touching the hot dummy load. Touch only when cooled down.

11 Demounting



Before you start, ensure to read and understand the Basic Safety Instructions and the additional safety instructions on personal safety that appear in relevant parts of this manual. Failure to observe could result in death or serious injury. Only electrically skilled persons may demount SPINNER dummy loads in accordance with the national safety and accident prevention regulations.

WARNING

Electric shock hazard



Electric shock can cause severe burns and fatal injuries.

Before you start ensure to disconnect your entire system from the power supply.

Utilize appropriate devices and methods to prevent accidental energizing. The dummy load is not equipped with separating equipment for safe disconnection from mains. Unplug the power cord for safe disconnection from mains. Unplug the interlock loop connector.

WARNING

Radio Frequency Hazard



Radio Frequency Power can cause burns, eye injuries and electrical shock. Before you start ensure to disconnect your entire system from the power supply. Utilize appropriate devices and methods to prevent accidental energizing.

12 Disposal

The user is responsible for disposing of the dummy load in accordance with the national waste disposal regulations. Improper disassembly or disposal may be hazardous.

13 Spare Parts

Designation	Order-No.	Qty.
Mains adaptor 24 V	BN 155815	1
Interlock cable connector	BN 102964	1
Fastening angle set	BN B26061	1

14 Contacts

SPINNER GmbH**Headquarters**

Erzgiessereistr. 33

80335 München

Germany

tel.: +49 89 12601-0

fax: +49 89 12601-1292

info@spinner-group.comwww.spinner-group.com**SPINNER Telecommunication****Devices Co., Ltd.**

351 Lian Yang Road

Songjiang Industrial Zone

Shanghai

201613 P.R. **China**

tel.: +86 21 577 45377

fax: +86 21 577 40962

info-china@spinner-group.com