

Waveguide Pressure Window R 320 || BN 664762

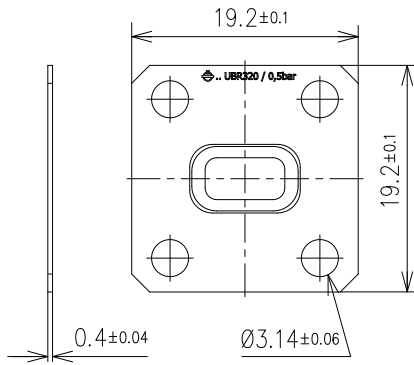

all dimensions in millimeter

Interface type	similar UBR 320 per IEC 60154-2
Frequency range	26.3 to 40 GHz
VSWR, max.	1.06
Material	copper alloy
Surface finish	untreated
Other parts	PI foil
Differential operating pressure, max.	0.05 MPa (0.5 bar), both-way
Weight, approx.	1 g