

50 dB Coupler (H-Style)

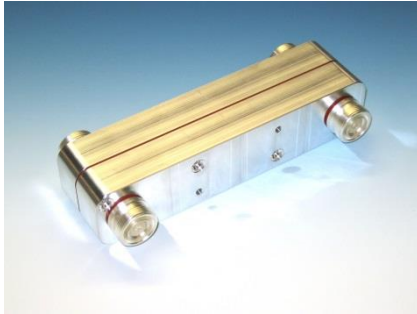

not binding

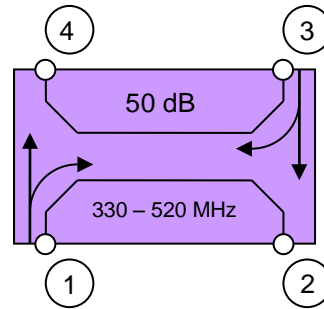

block diagram

Part number	BN 753385
Connectors	7-16 socket (50 Ohms)
Frequency range	330 - 520 MHz (Tetra)
Insertion loss	≤ 0.2 dB
Coupling attenuation	50 dB +/- 1.0 dB
Isolation	≥ 80 dB
VSWR	≤ 1.06
Test voltage	500 V
Power rating	max. 1000 W
Degree of protection mated / 1bar, 1h, ≤18°C	IP 68
Environmental conditions	ETSI EN 300019-1-1 Class 1.2 ETSI EN 300019-1-2 Class 2.3 ETSI EN 300019-1-4 Class 4.1E
Wall / Mast mounting	to be ordered separately under BN B13702
Weight	1.4 kg
Temperature range	-40 – +55 °C

Dimensions:

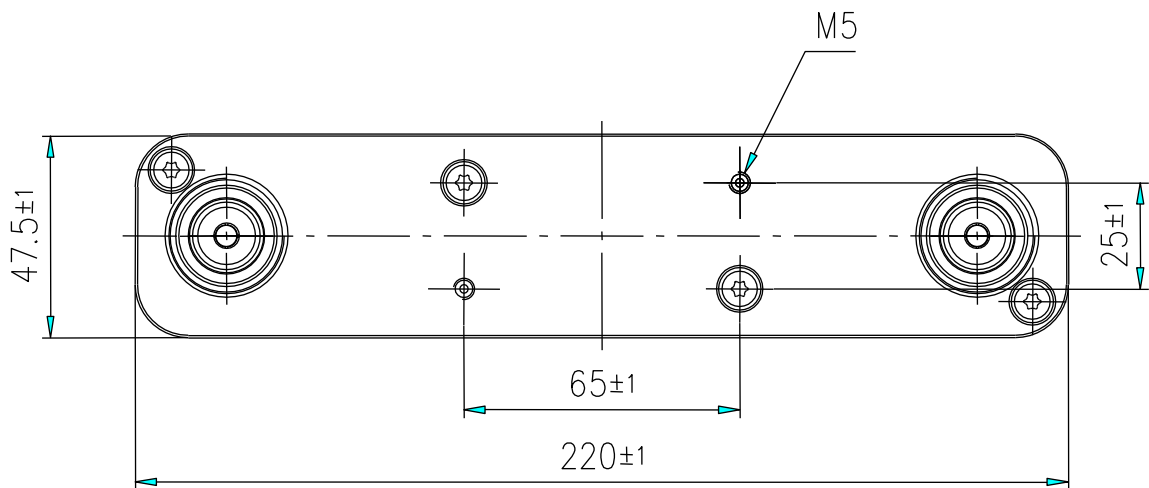
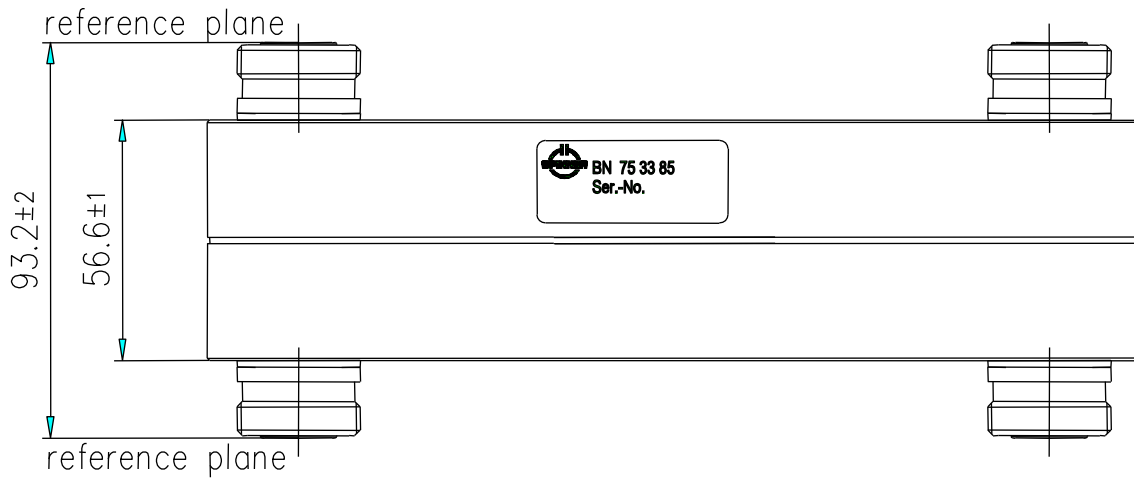

modifications reserved

Measurements:

