

Waveguide Pressure Window R 100 || BN 865861

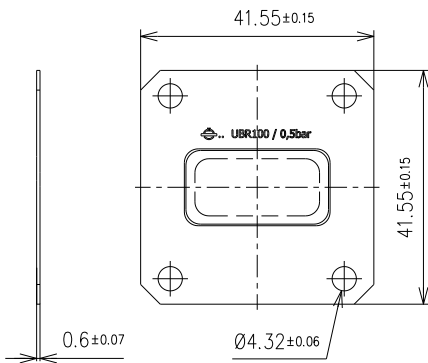

all dimensions in millimeter

Interface type	similar UBR 100 per IEC 60154-2
Frequency range	8.2 to 12.5 GHz
VSWR, max.	1.03
Material	copper alloy
Surface finish	untreated
Other parts	PI foil
Differential operating pressure, max.	0.05 MPa (0.5 bar), both-way
Weight, approx.	7 g