

Waveguide Pressure Window R 140 || BN 865959

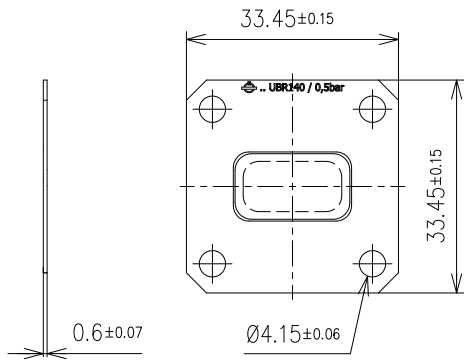

all dimensions in millimeter

Interface type	similar UBR 140 per IEC 60154-2
Frequency range	11.9 to 18 GHz
VSWR, max.	1.04
Material	copper alloy
Surface finish	silver plated
Other parts	PI foil
Differential operating pressure, max.	0.05 MPa (0.5 bar), both-way
Weight, approx.	6 g