

SISO V-Pol Panel Antenna, 694MHz-4000MHz

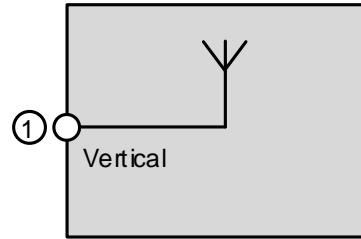

not binding



block diagram

Part number		BN A77140				
Connector		4.3-10 female (50 Ω)				
Frequency range, [MHz]		694-806	806-960	1350-1710	1710-2700	3400-4000
Gain, [dBi]		5.0±0.5	6.0±0.5	7.0±0.5	7.5±0.5	8.5±0.5
Polarization		Vertical				
Beam width, [deg]	Horizontal	80	80	65	60	55
	Vertical	73	70	60	60	30
Front-To-Back Ratio, [dB]		≥5	≥8	≥10	≥12	≥10
VSWR		≤2.0				
Intermodulation (IM3) @ 2x 20 W, [dBc]		≤-153				
Input power, [W]		max. 50				
Degree of protection		Indoor / IP54				
Weight, without Mounting Kit, [kg]		0.4				
Radome Material and Color		ABS, White, RAL9003				
Temperature range, [°C]		-55 – +60				
Dimensions (H x W x D), [mm]		180 x 170 x 60				
Operational Humidity		<95%				
RoHS		Compliant				
Flammability rating		UL 94-V0				
Fire load, [kWh]		2.18				
Installation instructions		M36536				
Mounting Kit		On-wall				

Radiation pattern:

Horizontal pattern

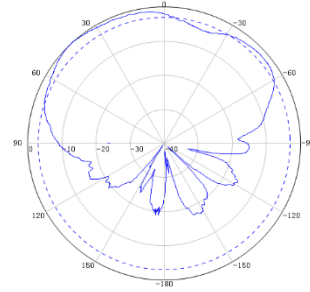
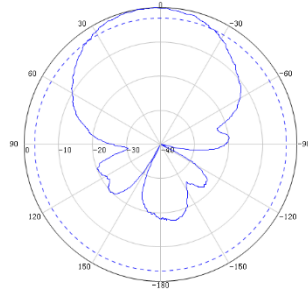
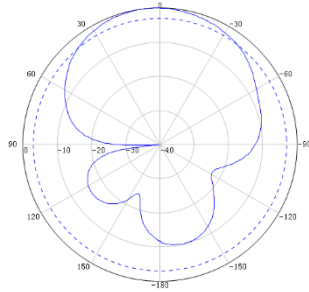

Vertical pattern

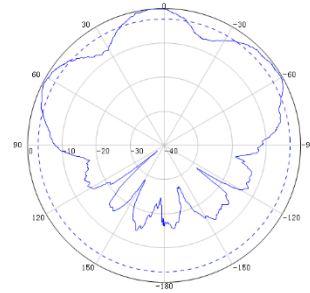
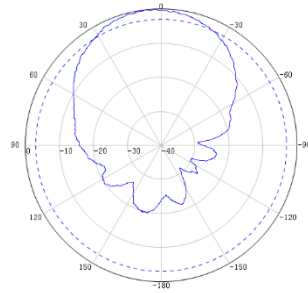
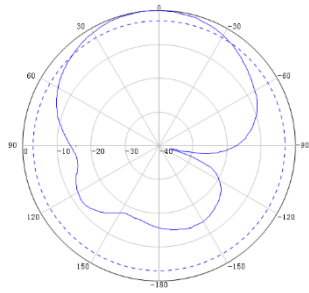

900MHz

1880MHz

3500MHz

Dimensions and mounting:

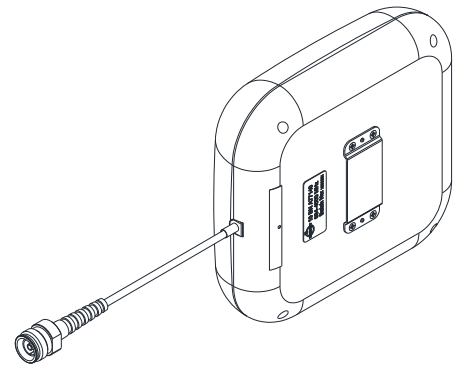
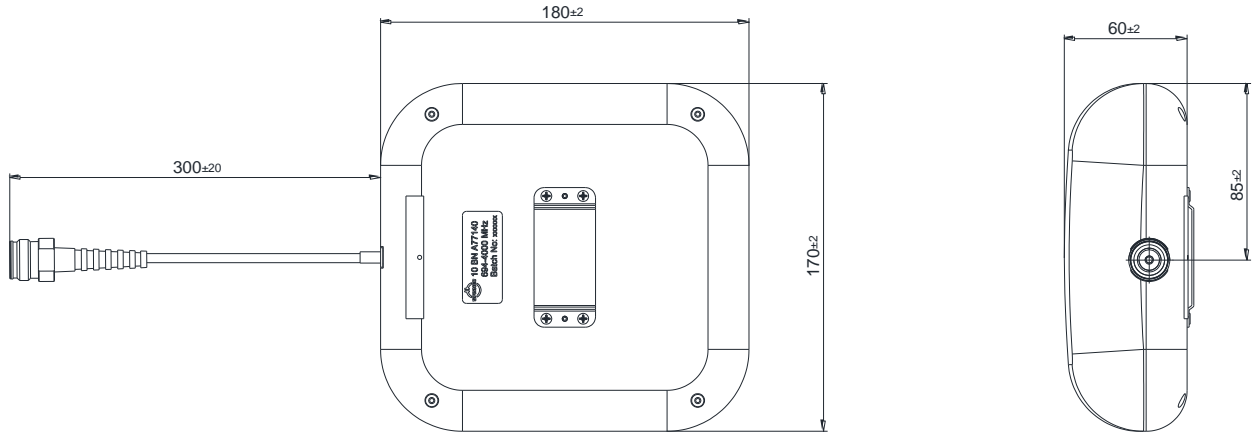

Standard:

4.3-10 female (50 ohms): IEC 61169-54

Subject to change without notice

Mounting kit:

