

Fixed Socket for RG401/U Type 2.2-5 || BN 225044

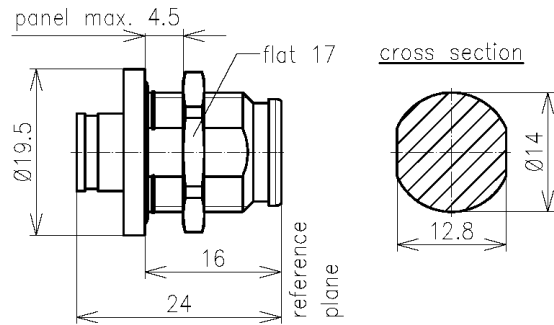

all dimensions in millimeter

Interface type	2.2-5 socket (50 Ω) per IEC 61169-66
Version	bulkhead mounting, soldered
Frequency range	DC to 6 GHz
VSWR, max. / typ.	1.02 @ DC to 1 GHz 1.04 @ 1 to 2.2 GHz 1.10 @ 2.2 to 3.8 GHz 1.15 @ 3.8 to 6 GHz
Intermodulation (IM3) @ 2x 20W, max.	-165 dBc
Inner conductor material / surface finish	copper alloy / silver plated
Outer conductor material / surface finish	copper alloy / silver plated
Other metal parts / surface finish	copper alloy / CuSnZn plated
Insulation	PTFE
Sealing	silicone rubber
IP protection level	IP68 per EN 60529 (interface connected with appropriate gasket)
Cable compatibility	RG401/U; SX250
Weight, approx.	20 g
Scope of delivery	Inner conductor added separately, installation instructions

SPINNER GmbH | This document is proprietary to us. All rights reserved. Any use, transfer, or reproduction of this document or the know-how contained therein requires our express consent.