

Rotary Joint || BN 549758C1000

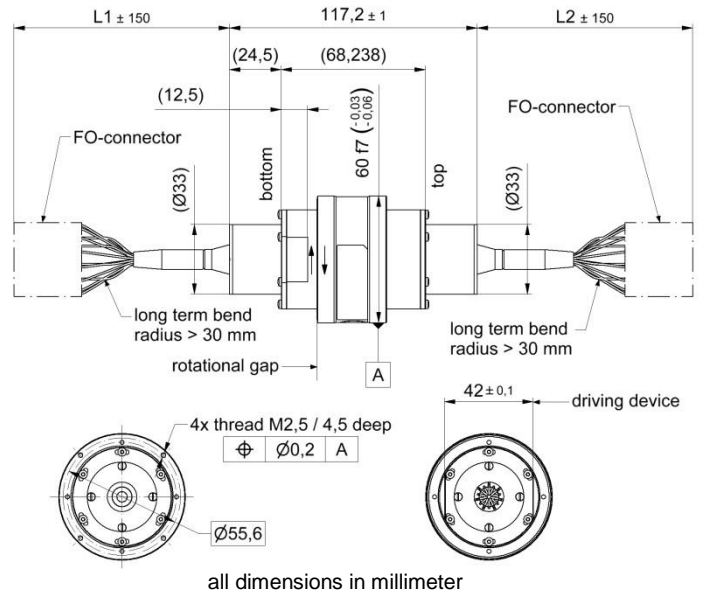
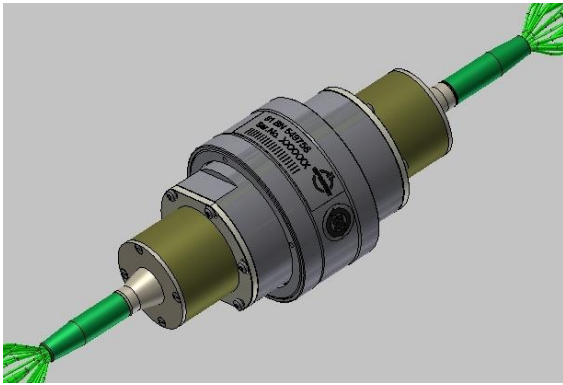

Fiber optic channel characteristics

Channels	10 CH
Channel designation	1 to 10
FO connector / material	LC-APC / ceramic
Fiber type	Singlemode E9 / 125 μ m / 900 μ m buffer
Fiber length (L1 / L2)	1500 mm / 1500 mm
Wavelength	1310 nm / 1550 nm
Average power capability, max.	200 mW / 23 dBm
Return loss, min. / typ.	50 dB / 55 dB
Insertion loss, max.	3.5 dB
Insertion loss variation over rotation, max.	1.5 dB
Cross talk, min.	50 dB (between all channels)

Rotary Joint || BN 549758C1000

Mechanical characteristics

Rotating speed, max. / nominal	150 rpm / 100 rpm
Life, min.	20 x 10 ⁶ revolutions ^{F01)}
Torque (room temperature), max.	0.15 Nm @ rotation
Interface loads, max.	±0.4 Nm bending moment
Case material	stainless steel and copper alloy, corrosion resistant
Case surface finish	no finish
IP protection level	IP50 per EN 60529 (all interfaces connected with appropriate gaskets)
Weight, approx.	1.5 kg
Marking	adhesive label

^{F01)} up to 200 x 10⁶ revolutions with dedicated environmental conditions.

Environmental conditions

Operation	
Ambient temperature range	-40 °C to +85 °C
Relative humidity, max.	95% (non-condensing)
Shock	30 g / 11 ms half sine, 3 shocks in each direction of 3 orthogonal axes
Vibration	6 to 17 m/s ² rms, 5.1 to 480 Hz, in three orthogonal axis
Storage	
Ambient temperature range	-40 °C to +85 °C
Relative humidity, max.	95% (non-condensing)

Applicable documents

Technical information	"Rotary Joints – Glossary", Technical Document TD-00021, Spinner GmbH
-----------------------	---