

UMTS Outdoor Two-way Filter

Connectors:

7-16 socket (50 Ohms)

Frequency range:

Passband: 1900 – 1910 MHz
 1980.5 – 1990 MHz
 Stopband: 1915 – 1975 MHz

Insertion loss: ≤ 1.6 dB

Isolation: ≥ 40 dB

VSWR: ≤ 1.2

IM – value:

3rd order @ 2 x 20 W ≤ -155 dBc

Power rating: 100 W (CW)

Degree of protection: IP 65 outdoor

Weight: 6.9 kg

Wall / Mast mounting: part of delivery

Temperature range: -25 °C – +65 °C

Appendix:

Dimensions
 Measurements for VSWR
 Insertion loss
 Isolation

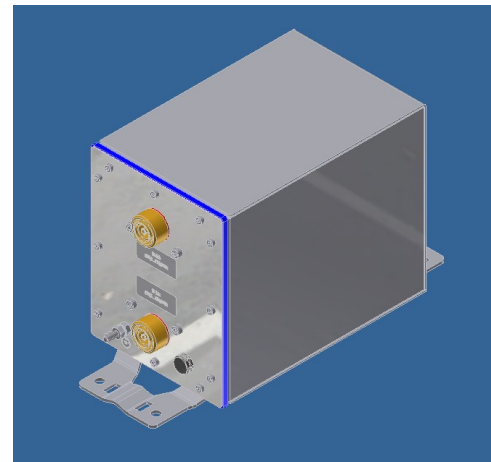

not binding

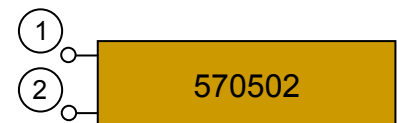

block diagram

Dimensions:

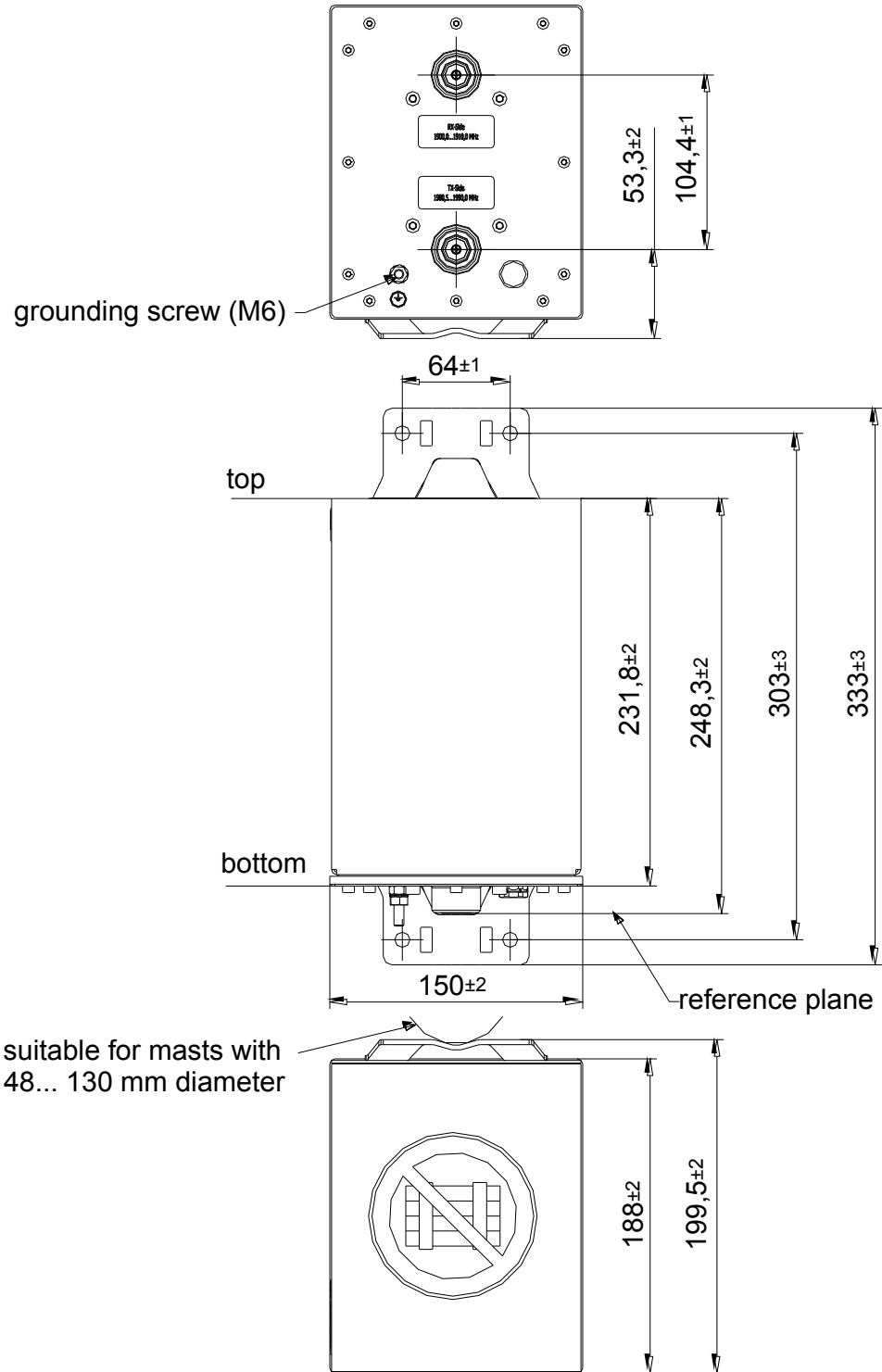

constructional modifications reserved

VSWR:

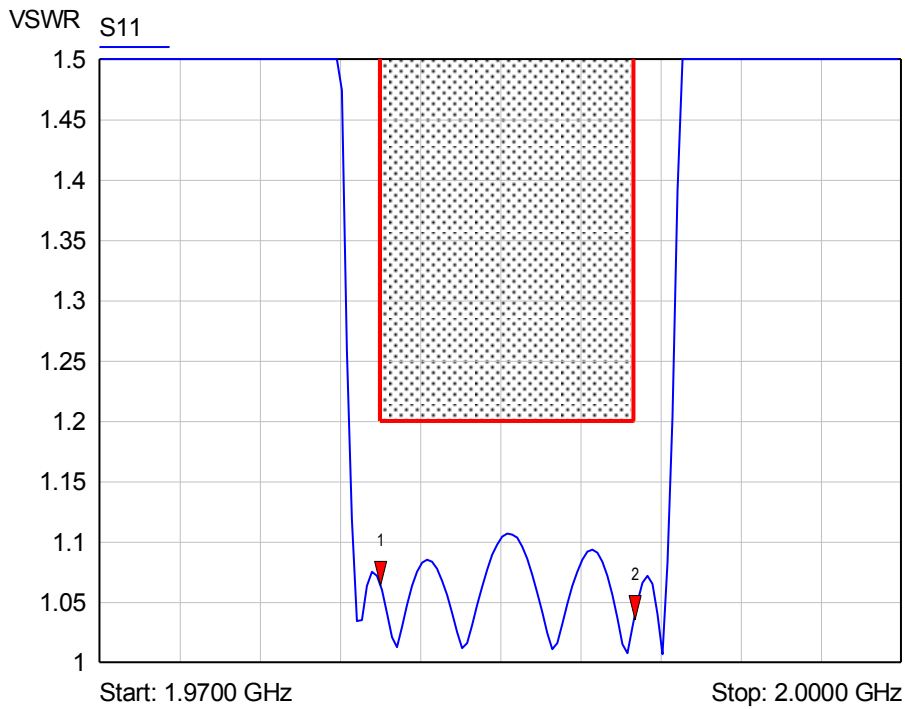
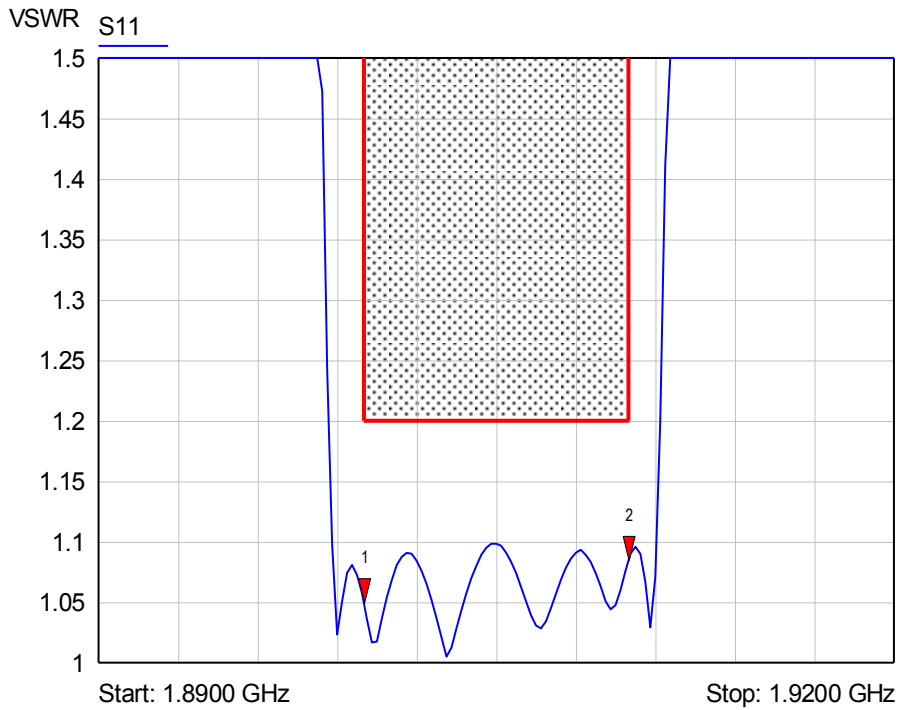

Insertion loss:

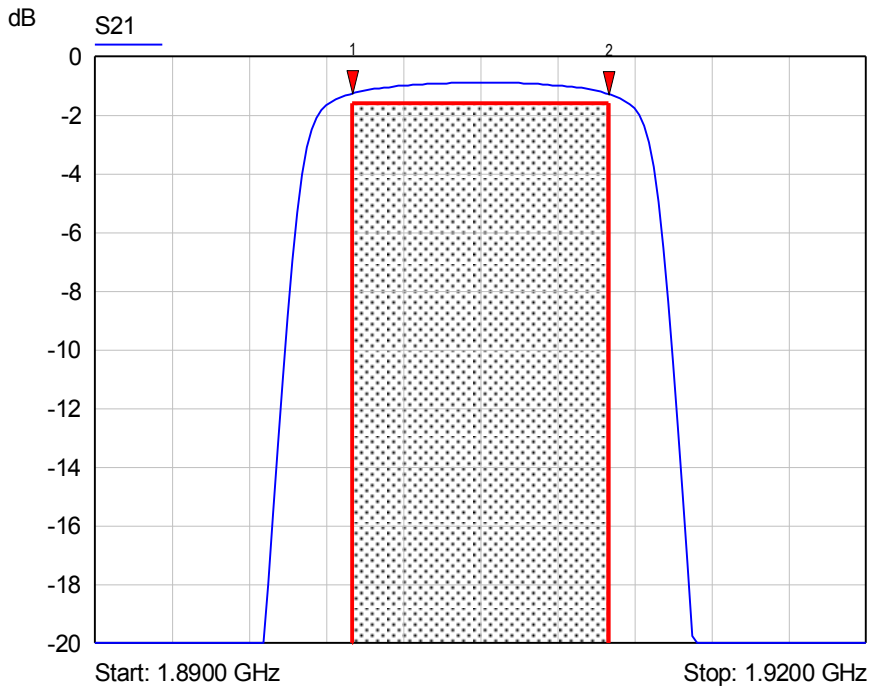

- 1 S21
▼ 1.9000 GHz
-1.27 dB
- 2 S21
▼ 1.9100 GHz
-1.28 dB

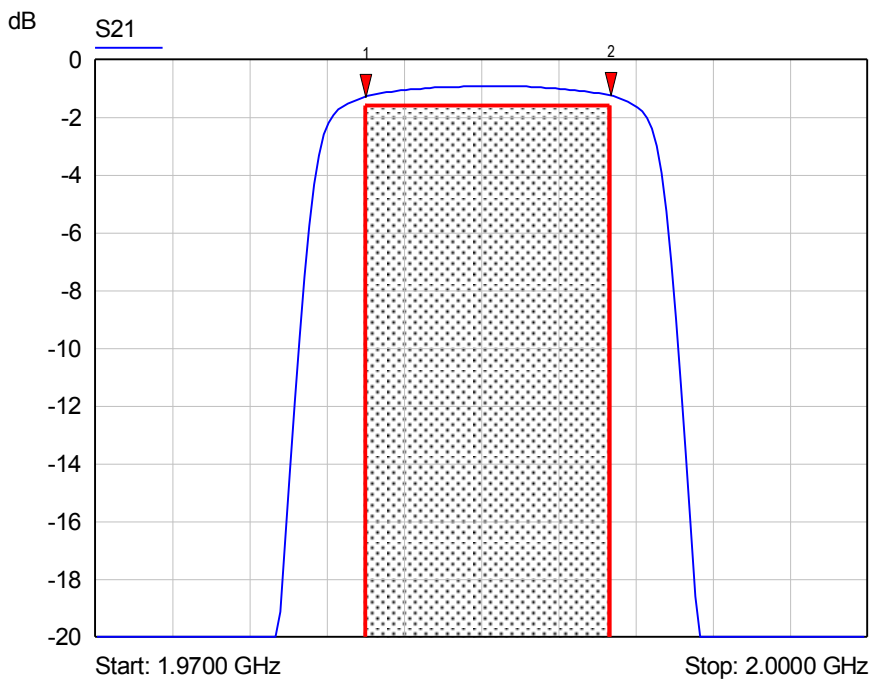

- 1 S21
▼ 1.9805 GHz
-1.30 dB
- 2 S21
▼ 1.9900 GHz
-1.25 dB

Isolation:

