

Waveguide Pressure Window R 120 || BN 617662

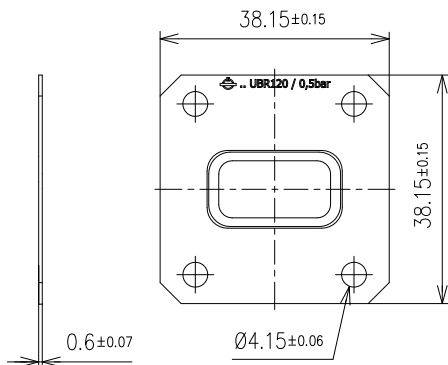

all dimensions in millimeter

Interface type	similar UBR 120 per IEC 60154-2
Frequency range	9.84 to 15 GHz
VSWR, max.	1.04
Material	copper alloy
Surface finish	untreated
Other parts	PI foil
Differential operating pressure, max.	0.05 MPa (0.5 bar), both-way
Weight, approx.	6 g