

Waveguide Pressure Window R 180 || BN 617762

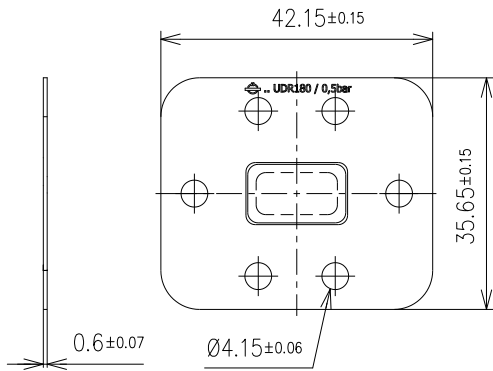

all dimensions in millimeter

Interface type	similar UDR 180 per IEC 60154-2
Frequency range	14.5 to 22 GHz
VSWR, max.	1.04
Material	copper alloy
Surface finish	untreated
Other parts	PI foil
Differential operating pressure, max.	0.05 MPa (0.5 bar), both-way
Weight, approx.	8 g