



# SPINNER || PRODUCT MANUAL



## **RF plug-in switch (DPDT)**

Coaxial interface: 1 5/8" USL-D

BN 553064

BN 553065

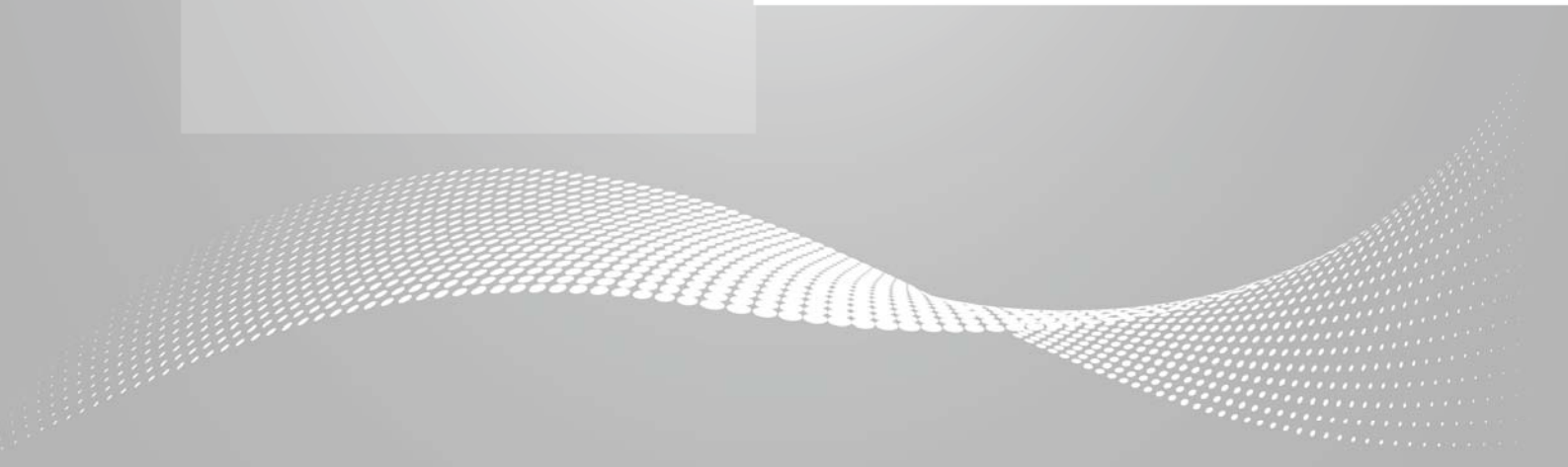

**High Frequency Performance Worldwide**

[www.spinner-group.com](http://www.spinner-group.com)

## Content

1.	Basic Safety Instructions for SPINNER Broadcast Products .....	3
2.	Intended use.....	6
3.	Improper use .....	6
4.	Function.....	6
4.1	Motor drive .....	6
4.2	SPINNER crank drive.....	6
4.3	Bistable switching property (latching).....	7
4.4	Manual override.....	7
4.5	Visual position indicator .....	7
4.6	Interlock / signal contacts.....	7
4.7	Earthing terminal .....	7
4.8	Strapping plug for USL-interlock I .....	7
5.	Data sheet.....	8
6.	Dimensions (all dimensions in millimeters).....	11
7.	Circuit diagrams .....	12
8.	Storage.....	14
9.	Transportation .....	14
10.	Installation .....	14
10.1	Mechanical and RF installation .....	15
10.2	Electrical installation.....	16
11.	Commissioning.....	18
12.	Operation.....	18
13.	Cleaning .....	18
14.	Maintenance.....	19
15.	Repairs .....	19
16.	Warranty.....	19
17.	Demounting .....	19
18.	Disposal.....	20
19.	Additional endangering (regardless to life cycle) .....	20
20.	Environmental friendly usage period.....	21
21.	Spare parts.....	21
22.	Accessories (not in delivery) .....	21
23.	Contacts .....	22

## 1. Basic Safety Instructions for SPINNER Broadcast Products

The following instructions and safety instructions are to be carefully read and followed!











The Spinner group makes every effort to keep the safety standard of our products up to date to be able to offer our customers the highest possible degree of safety. Our products are designed and tested in accordance with the relevant safety standards. Compliance with these standards is continuously monitored by our quality assurance system. The product described here has been designed and tested in accordance with the respective EU guidelines and has left the manufacturer's plant in a condition fully complying with safety standards. To maintain this condition and to ensure safe operation, observe all instructions and warnings provided. If you have any questions regarding these safety instructions, the Spinner group will be happy to answer them.

The operator is responsible for using the product in an appropriate manner. This product must not be used in any way that may cause personal injury or property damage. The operator is responsible if the product is used for an intention other than its designated purpose or in disregard of the manufacturer's instructions. The manufacturer shall assume no responsibility for such use of the product.

The product is used for its designated purpose if it is used according to the specifications listed in the product's documentation within its performance limits (see data sheet, performance specifications, circuit diagram, the following safety instructions).

Putting the product into operation requires special technical skills and must be executed by qualified personnel with reference to "Start-up information" in the product documentation. Keep the basic safety instructions and the product documentation in a safe place and pass them on to the subsequent users.

### Symbols and safety markings

					
General hazard	Warning! Risk of electric shock	Warning! Hot surface	PE terminal	Earthing terminal	Warning! High weight
					
Warning! Non-ionised electromagnetic radiation	Pacemaker hazard area	Use foot guard	Use eye protection	Use safety gloves	Observe product documentation

Observing the safety instructions will help prevent personal injury or damage of any kind caused by dangerous situations. Therefore, carefully read through and adhere to the following safety instructions before putting the product into operation. It is also absolutely essential to observe the additional safety instructions on personal safety that appear in relevant parts of the product documentation.

### Tags and their meaning

- DANGER** Indicates a hazardous situation conveying great risk which, if not avoided, will result in death or serious injury.
- WARNING** Indicates a hazardous situation conveying moderate risk which, if not avoided, could result in death or serious injury.
- CAUTION** Indicates a hazardous situation conveying minor risk which, if not avoided, may result in minor or moderate injury.
- ATTENTION** Indicates the possibility of faulty operation that can damage the product.

These tags are in accordance with the standard definition for civil applications in the European Economic Area. Definitions that deviate from the standard definition may also exist in other economic areas or military applications. It is therefore essential to make sure that the tags described here are always used only in connection with the related product documentation and the related product. The use of tags in connection with unrelated products or documentation can result in misinterpretation and thus contribute to personal injury or material damage.

1. These products must be operated only under the operating conditions specified in the product documentation. All instructions for start-up, operation and servicing listed in the product documentation have to be observed.
2. Applicable local or national safety regulations and rules for the prevention of accidents must be observed in all work performed. Only authorized and specially trained personnel shall work with these products.
3. Operating the products requires special training and intense concentration. Make sure that persons who use the products are physically, mentally and emotionally fit enough to do so; otherwise, injuries or material damage may occur. It is the responsibility of the employer/operator to select suitable personnel for operating the products.
4. The product must be installed and operated in operating sites with limited access only. Access for authorized qualified personnel must be regulated by the operator.
5. Unless otherwise specified, these products are not protected against penetration of liquids, gases, steam, etc. If this is not taken into account, there exists the danger of electric shock for the user or damage to the product, which can also lead to personal injury.
6. Never use the product under conditions in which condensation has formed or can form in or on the product, unless otherwise specified.
7. These products are not explosion protected. They must not be operated in explosion-prone areas.
8. Do not place the product on heat-generating devices such as radiators or fan heaters. The ambient temperature must not exceed the maximum temperature specified in the product documentation. Product overheating can cause electric shock, fire and/or serious personal injury or death.
9. Do not place the product on surfaces, vehicles, cabinets or tables that for reasons of weight or stability are unsuitable for this purpose. Always follow the manufacturer's installation instructions when installing the product and fastening it to objects or structures (e.g. walls and shelves). An installation that is not carried out as described in the product documentation could result in personal injury or death.
10. The product may be very heavy. Therefore, the product must be handled with care. In some cases, the user may require suitable lifting gear to avoid back or other physical injuries.
11. The user is responsible for safe transport, parking and storage of the product. When using auxiliary objects (e.g. lifting gear, trolleys, shelves), the user has the duty to review their suitability prior to use. Transport and storage of the product are permitted only in the manufacturer's original packaging.
12. Handles on the product are handling aids and intended solely for people. Therefore, it is not permitted to use the handles for mounting on or at means of transportation, e.g. cranes, carts etc. Lifting lugs serve for transportation or lifting with crane.
13. Mains driven products must be operated only from a power distribution system. The operator is responsible for using an appropriate and sufficiently dimensioned AC power line. The AC power line must be externally fused according to the product documentation.
14. Operation of products of safety class I is only permitted with sufficient "Protective Earth" connection. Connection to "Protective Earth" must be done in the way provided and described in the product documentation. The operator is responsible for inspecting PE continuity by a qualified professional.
15. All connectors on cables from and to the product must be connected firmly. The connectors shall not be dusty or dirty. Otherwise, danger of fire and/or injuries can occur. Intentionally breaking the protective earth connection either in the AC power line or in the product itself is not permitted. Doing so can result in the danger of an electric shock from the product. If extension cables are used, they must be sufficiently dimensioned and checked on a regular basis to ensure that they are safe to use.
16. Do not overload any sockets, extension cords or connector strips; doing so can cause fire or electric shocks.
17. Operation of the product with a damaged cable is not permitted. All cables must be checked on a regular basis to ensure that they are in proper operating condition. By taking appropriate safety measures and carefully laying the power cable, ensure that the cable cannot be damaged and that no one can be hurt by e.g. tripping over the cable or suffering an electric shock.
18. If the product is equipped with an earthing terminal connection (equipotential connection), the earthing terminal must be connected sufficiently dimensioned to earth.
19. If a product is to be permanently installed, the connection between the PE terminal on site and the product's PE conductor must be made first before any other connection is made. The product may be installed and connected only by a licensed electrician.
20. For permanently installed equipment without built-in fuses, circuit breakers or similar protective devices, the supply circuit must be fused in such a way that anyone who has access to the product, as well as the product itself, is adequately protected from injury or damage.
21. Use suitable overvoltage protection to ensure that no overvoltage (such as that caused by a bolt of lightning) can reach the product. Otherwise, the person operating the product will be exposed to the danger of an electric shock.
22. Any object that is not designed to be placed in the openings of the housing must not be used for this purpose. Doing so can cause short circuits inside the product and/or electric shocks, fire or injuries.
23. Dangerous voltage must not reach the product over the outer conductor / waveguide.

24. All externally connected circuits for control, alarm and signalling must be supplied by SELV power sources (SELV according to DIN EN 60950-1). The current in these circuits must be limited to the values specified in the product documentation by means on an external fuse.
25. Before applying RF power to the product, it must be ensured that all connecting elements are professionally connected and all unused ports are terminated. RF connections must have sufficient mechanical strength. If the product features an interlock system, it must be connected and tested for function in advance.
26. Unless expressly permitted, never remove the cover or any part of the housing while the product is in operation. Doing so will expose circuits and components and can lead to injuries, fire or damage to the product.
27. Repairs must be carried out by the manufacturer or technical personnel authorized by the manufacturer only.
28. As with all industrially manufactured goods, the use of substances that induce an allergic reaction (allergens) such as nickel cannot be generally excluded. If you develop an allergic reaction (such as a skin rash, frequent sneezing, red eyes or respiratory difficulties) when using a SPINNER product, consult a physician immediately to determine the cause and to prevent health problems or stress.
29. Broadcasting systems or improper use of this product may produce an elevated level of electromagnetic radiation. Considering that unborn babies require increased protection, pregnant women must be protected by appropriate measures. Persons with pacemakers may also be exposed to risks from electromagnetic radiation. The employer/operator must evaluate workplaces where there is a special risk of exposure to radiation and, if necessary, take measures to avert the potential danger.
30. In the event of a fire, the product may release hazardous substances (gases, fluids, etc.) that can cause health problems. Suitable measures must be taken, e.g. wearing of protective masks and protective clothing.
31. Products in operation may be hot. Touching them might cause burns.
32. If the product is pressurized, applicable local or national safety regulations for pressure equipment must be observed.
33. Blocking of constructive openings on the product (ventilation slots, fine leaks etc.) must be prevented to ensure safe operation.
34. Before cleaning, disconnect the product and all transmitters connected to the product from mains. Use a soft, but not damp lint-free duster for cleaning. Do not use any chemical cleaning agents.
35. If handling the product releases hazardous substances or fuels that must be disposed of in a special way, e.g. coolants that must be replenished regularly, the safety instructions of the manufacturer of the hazardous substances and the applicable regional waste disposal regulations must be observed. Also observe the relevant safety instructions in the product documentation. The improper disposal of hazardous substances can cause health problems and lead to environmental damage.
36. The operator is responsible for disposing of the product according to national waste disposal regulations. Improper disassembly or disposal may be hazardous.
37. SPINNER RF switches are not equipped with separating equipment for safe disconnection from mains. The user must provide external separation equipment. The mains connector must be de-energized during plugging.
38. Do not actuate RF position I and RF position II of RF switches simultaneously to avoid RF switch damage.
39. Do not touch or block the emergency manual override during electrical switch over to avoid injuries and switch damage.
40. Disconnect RF switches from mains before using the emergency manual override of the drive unit to avoid injuries and switch damage. The emergency manual override serves solely for switching the RF switch manually in a dead state.
41. Switch over RF switches only without applying RF power to avoid injuries and damage. Hot switching with RF on is not permitted. Ensure all switches are in the respective end position before applying RF power.
42. Switch off RF power before disconnecting RF connectors to avoid burns, eye injuries and electric shock. Utilize appropriate devices and methods to prevent accidental energizing.

## 2. Intended use

The intended use of the product is switching over (Double Pole Double Through or Single Pole Double Through) between two coaxial paths of an RF system in indoor applications on operating sites with limited access. Details and other limits are given in the data sheet of this manual.



The product may only be operated within the specifications given in the data sheet of this manual. Failure to observe could result in death or serious injury.

## 3. Improper use

The product is not intended for any other purpose than indicated above.

Do not use

- in explosion-prone atmosphere
- on operating sites with unlimited access
- in outdoor applications
- to support mechanical loads
- with modifications not authorized by SPINNER
- in damaged condition
- without correctly connected interlock system
- in conditions and environments beyond the specifications given in the data sheet of this manual

If the RF plug-in switch is not used as intended, safe operation of this product cannot be guaranteed. The user is responsible for all personal injury and property damage resulting from improper use. Reading the manual as well as adhering to all the information provided – particularly the safety instructions - is considered mandatory to comply with the intended use.

## 4. Function

### 4.1 Motor drive

A capacitor motor with a supply voltage of 230 V AC 50/60 Hz is used to actuate the RF plug-in switch via a special crank gear box developed by SPINNER. Depending on the type of switch the drive control system enables remote switching by means of a control voltage of 230 V AC, 50/60 Hz or 8 to 31 V DC.

Order number	Control voltage
BN 553064	8 V DC to 31 V DC
BN 553065	230 V AC

### 4.2 SPINNER crank drive

To avoid contact bounce at fast switching time, the switch is equipped with a crank gear box. It effectuates a change of torque and angular speed during the switching process. At the beginning of the switching process, the crank gear box offers very high torque at low angular speed. With increasing rotation angle of the switch, the angular speed increases continuously, while the torque decreases. The behaviour reverses after passing the centre position of the switch, i.e. the angular speed decreases while the usable torque increases. The drive unit is mechanically interlocked at the end positions.

### 4.3 Bistable switching property (latching)

The RF plug-in switches show a bistable switching behaviour. Switching takes place from one stable state into another after applying the control voltage. For this reason, an impulse control signal is sufficient. The minimum impulse length has to correspond to the maximum switching time (see data sheet of this manual). After completion of the switching process, the control voltage is no longer necessary. If the switch is in an end position and the operating voltage fails, the switch remains in the end position. This also applies to resetting.

The RF plug-in switch remains in an undefined switching state, if the operating voltage fails during the switching process. After reapplying the operating voltage, the RF plug-in switch continues the switching process until it reaches the originally demanded end position.

### 4.4 Manual override

The switch position can be selected by the user manually with the manual override. The RF plug-in switch is mechanically interlocked in the end position.

### 4.5 Visual position indicator

The RF plug-in switch features a visual position indicator on the drive unit (top side). The position indicators signal switched RF paths in the respective switch end positions.

### 4.6 Interlock / signal contacts



#### **WARNING**

Do not use the interlock loop for personal protection.

#### **ATTENTION**

Switch off all transmitters before actuating the RF plug-in switch.  
Do not use the interlock loop for operational switch-off of the transmitters.  
Connect all transmitters to the interlock loop to avoid RF plug-in switch damage.  
Hot switching is not permitted.

The interlock and signal contacts open before and close after switching of the RF contacts. Therefore the signal contacts can also be used for interlock purposes.

The interlock and signal contacts comply with the requirements for SELV (DIN EN 60950-1). The maximum permissible voltage is 42.4 V AC<sub>pk</sub> / 60 V DC. This applies to the loop voltage and the voltage between signal or interlock contacts and to the earthed casing. The circuit must be externally limited to 0.5 A.

### 4.7 Earthing terminal

To ensure equipotential bonding with other plant components, connect the marked earthing terminal to the main earthing busbar with a copper lead (min 6 mm<sup>2</sup>).

### 4.8 Strapping plug for USL-interlock I

The eccentrically placed interlock strapping plug is designed to open before and close after connecting of the RF connectors. Integration of the strapping plug into the interlock loop is mandatory to avoid hot switching in case of accidental removal of the RF plug-in switch from the patch panel.

The eccentric position of the strapping plug prevents attachment of the switch in an incorrect assembly position.

## 5. Data sheet

### Radio frequency characteristics

Interface type (4 connections)	1 5/8" USL-D according to company standard 61790		
Characteristic impedance	50 Ω		
Frequency range	0 to 100 MHz	100 to 230 MHz	230 to 860 MHz
VSWR, max.	1.04	1.04	1.04
Isolation, min.	80 dB	80 dB	70 dB
Insertion loss, max.	0.1 dB	0.1 dB	0.1 dB
Average power capability *	20 kW	13.5 kW	7 kW
Peak voltage capability *	7 kV		

### Electrical and mechanical data

Switch type	Two way switch, DPDT	
Actuator type	Motor drive, latching, self cutoff	
Strapping plug for USL-interlock I	Connector J3 ***	8 pole SPINNER connector BN 125651
	Maximum ratings	SELV circuits according to IEC EN 60950-1, 42.4 V ACpk / 60 V DC / 0.5 A
	Nominal fuse	The circuits must be externally limited to 0.5 A.
Connector J2 ** for mains connection	5 pole SPINNER connector BN 126920, certified according to VDE-Reg. No. B687, DIN EN 61984: 2009-11; EN 61984: 2009	
Mains connection	L, N, PE, TN-System	
Operating	Operating voltage	230 V AC ±10% 50/60 Hz
	Current, typ. ****	1 A
	Nominal fuse	The switch must be externally fused by time-delay, 2 A
Connector J1 ** for control, interlock contacts and signaling	25 pole connector according to DIN 41652 / IEC 807-2	
Control (only BN 553064)	Control voltage	SELV circuits according to IEC EN 60950-1, 8 to 31 V DC
	Current, typ.	22 mA
	Nominal fuse	The circuit must be externally fused with 0.5 A
Signal contacts Interlock contacts	Maximum ratings	SELV circuits according to IEC EN 60950-1, 42.4 V ACpk / 60 V DC / 0.5 A
	Nominal fuse	The circuit must be externally limited to 0.5 A
Switching time, typ. ****	0.2 s	
Command hold time, min.	0.2 s (during this time, the voltage at control input must not change)	
Switching frequency, max.	10 operations per minute	



Life, min.	250,000 operations
Weight, approx.	5 kg

## Environmental conditions

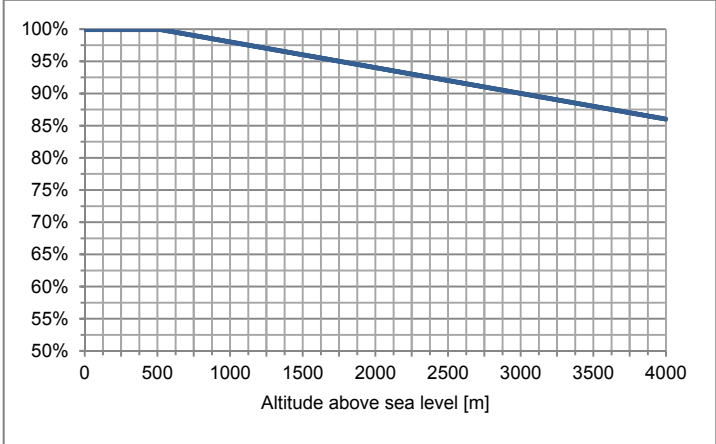
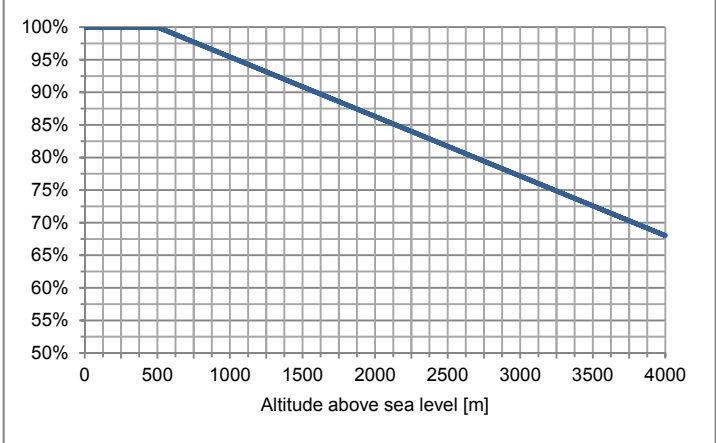
<b>Operational conditions</b>	ETSI EN 300 019-1-3 V2.3.2 (2009-1) class 3.1 N																				
Ambient temperature *****	-10 to +45°C																				
Condensation	Not allowed																				
Relative humidity, max.	95%																				
Derating of input power with increasing altitude	<p>The maximum input power can be applied up to 500 m or 1600 ft above sea level unless noted otherwise in the data sheet. Above this height the maximum input power must be reduced as shown in the diagram.</p>  <table border="1"> <caption>Derating of input power with increasing altitude</caption> <thead> <tr> <th>Altitude above sea level [m]</th> <th>Percentage</th> </tr> </thead> <tbody> <tr><td>0</td><td>100%</td></tr> <tr><td>500</td><td>100%</td></tr> <tr><td>1000</td><td>98%</td></tr> <tr><td>1500</td><td>96%</td></tr> <tr><td>2000</td><td>94%</td></tr> <tr><td>2500</td><td>92%</td></tr> <tr><td>3000</td><td>90%</td></tr> <tr><td>3500</td><td>88%</td></tr> <tr><td>4000</td><td>85%</td></tr> </tbody> </table>	Altitude above sea level [m]	Percentage	0	100%	500	100%	1000	98%	1500	96%	2000	94%	2500	92%	3000	90%	3500	88%	4000	85%
Altitude above sea level [m]	Percentage																				
0	100%																				
500	100%																				
1000	98%																				
1500	96%																				
2000	94%																				
2500	92%																				
3000	90%																				
3500	88%																				
4000	85%																				
Derating of voltage with increasing altitude	<p>The maximum voltage can be applied up to 500 m or 1600 ft above sea level unless noted otherwise in the data sheet. Above this height the maximum input power must be reduced as shown in the diagram.</p>  <table border="1"> <caption>Derating of voltage with increasing altitude</caption> <thead> <tr> <th>Altitude above sea level [m]</th> <th>Percentage</th> </tr> </thead> <tbody> <tr><td>0</td><td>100%</td></tr> <tr><td>500</td><td>100%</td></tr> <tr><td>1000</td><td>92%</td></tr> <tr><td>1500</td><td>84%</td></tr> <tr><td>2000</td><td>76%</td></tr> <tr><td>2500</td><td>68%</td></tr> <tr><td>3000</td><td>60%</td></tr> <tr><td>3500</td><td>52%</td></tr> <tr><td>4000</td><td>68%</td></tr> </tbody> </table>	Altitude above sea level [m]	Percentage	0	100%	500	100%	1000	92%	1500	84%	2000	76%	2500	68%	3000	60%	3500	52%	4000	68%
Altitude above sea level [m]	Percentage																				
0	100%																				
500	100%																				
1000	92%																				
1500	84%																				
2000	76%																				
2500	68%																				
3000	60%																				
3500	52%																				
4000	68%																				
Max. altitude above sea level	4,000 m or 13,120 ft according to IEC EN 60664-1																				
Protection class	I according to IEC EN 61140																				
IP protection level	IP40 according to IEC EN 60529 (all interfaces equipped with appropriate gaskets)																				

Installation position	Any
<b>Transport conditions</b>	ETSI EN 300 019-1-2 V2.1.4 (2003-04) class 2.2
Ambient temperature	-25 to +70°C
Rain, condensation, icing	Not allowed
<b>Storage conditions</b>	ETSI EN 300 019-1-1 V2.1.4 (2003-04) class 1.2
Ambient temperature	-10 to +45°C
Rain, condensation, icing	Not allowed

- \* *Standard conditions:*  
*Dielectric: Dry air under standard pressure at sea level ( $p = 1013 \text{ hPa}$ )*  
*Load VSWR, max. 1.0 (no standing wave)*  
*No modulation, sinusoidal carrier only*
- \*\* *Suitable mating connector included*
- \*\*\* *Suitable SPINNER mating connector BN 539145 not in delivery!*
- \*\*\*\* *At room temperature and nominal voltage 230 V AC*
- \*\*\*\*\* *Extended temperature range on request*

## 6. Dimensions (all dimensions in millimeters)

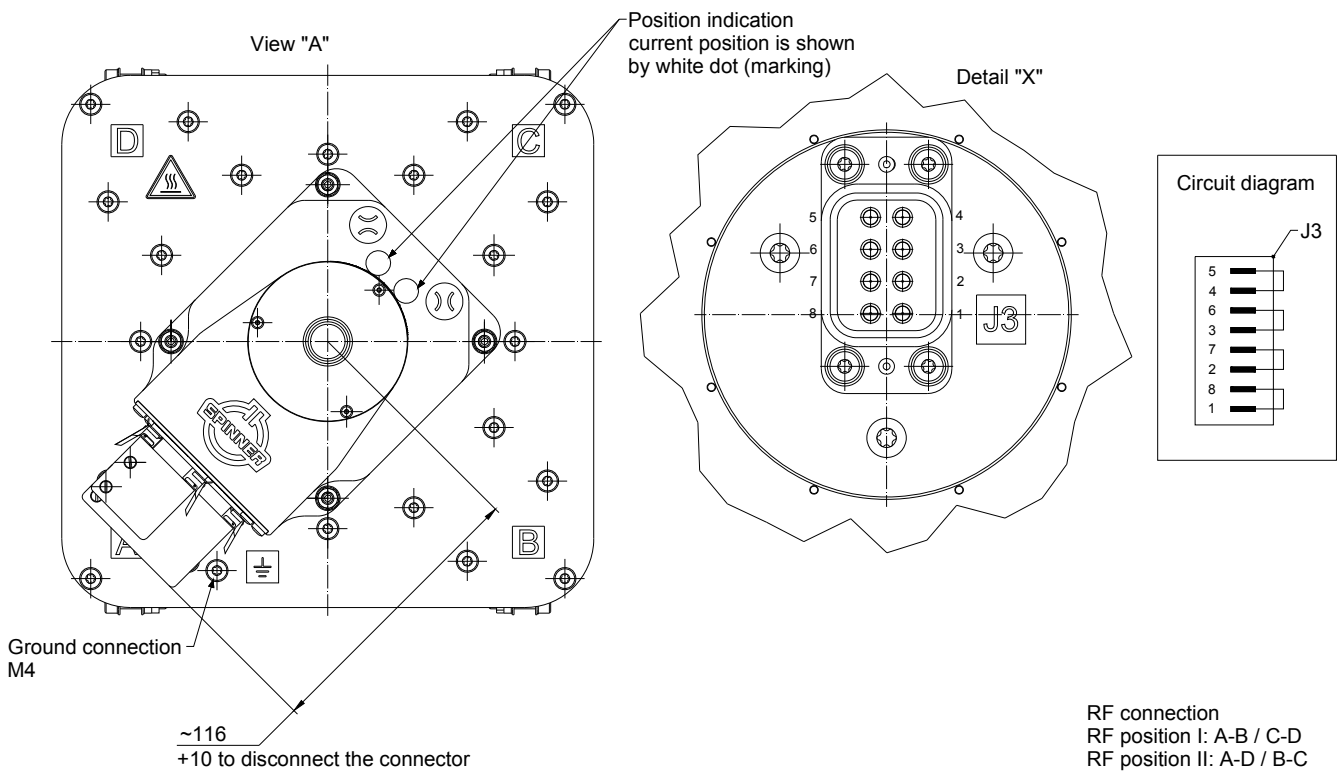
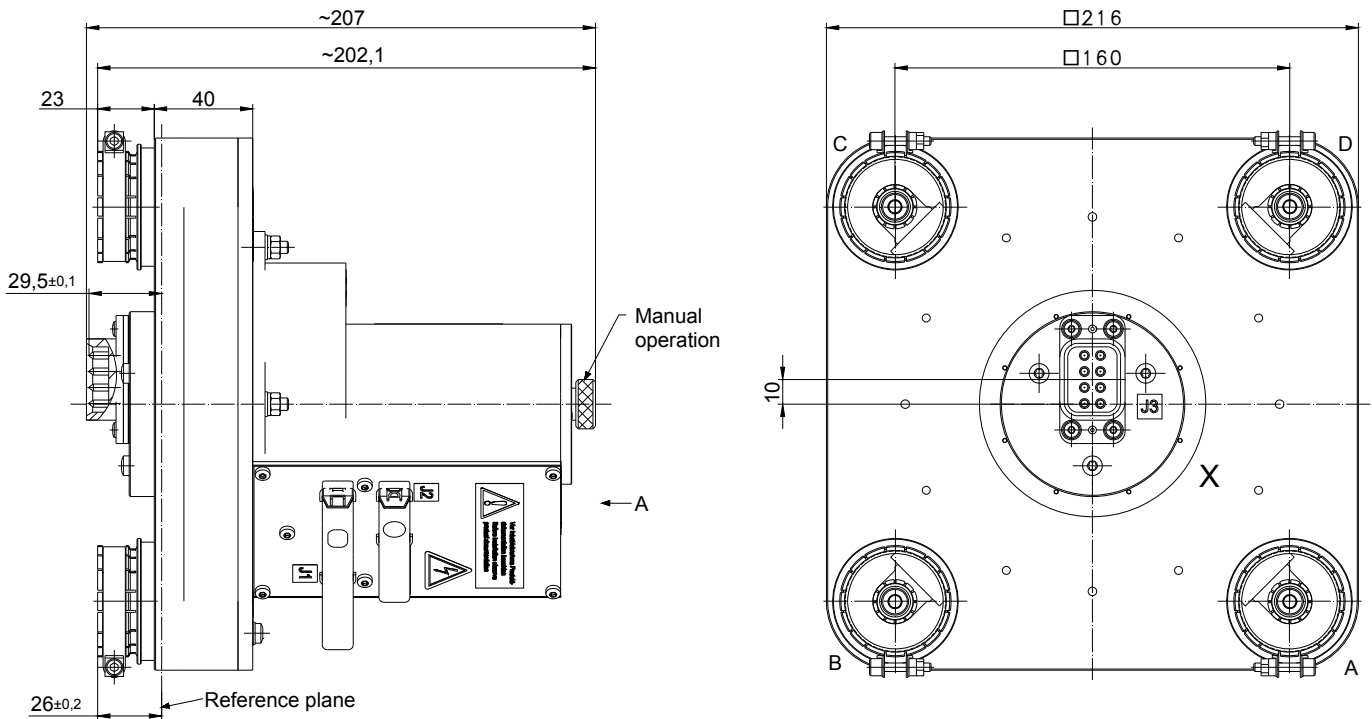

## 7. Circuit diagrams

No. B41003-CD Issue G, valid for BN 553064

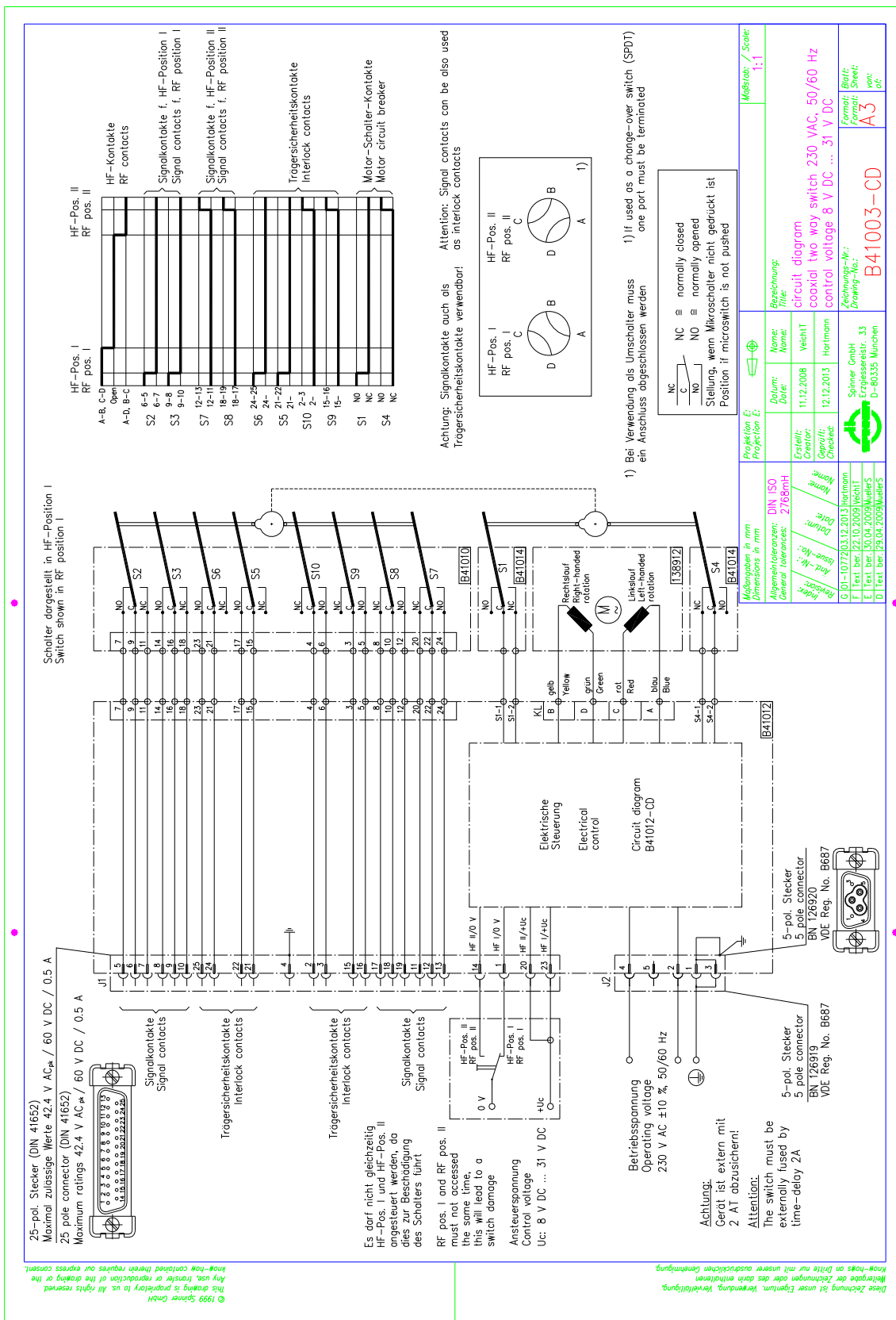

# No. B41001-CD Issue E, valid for BN 553065

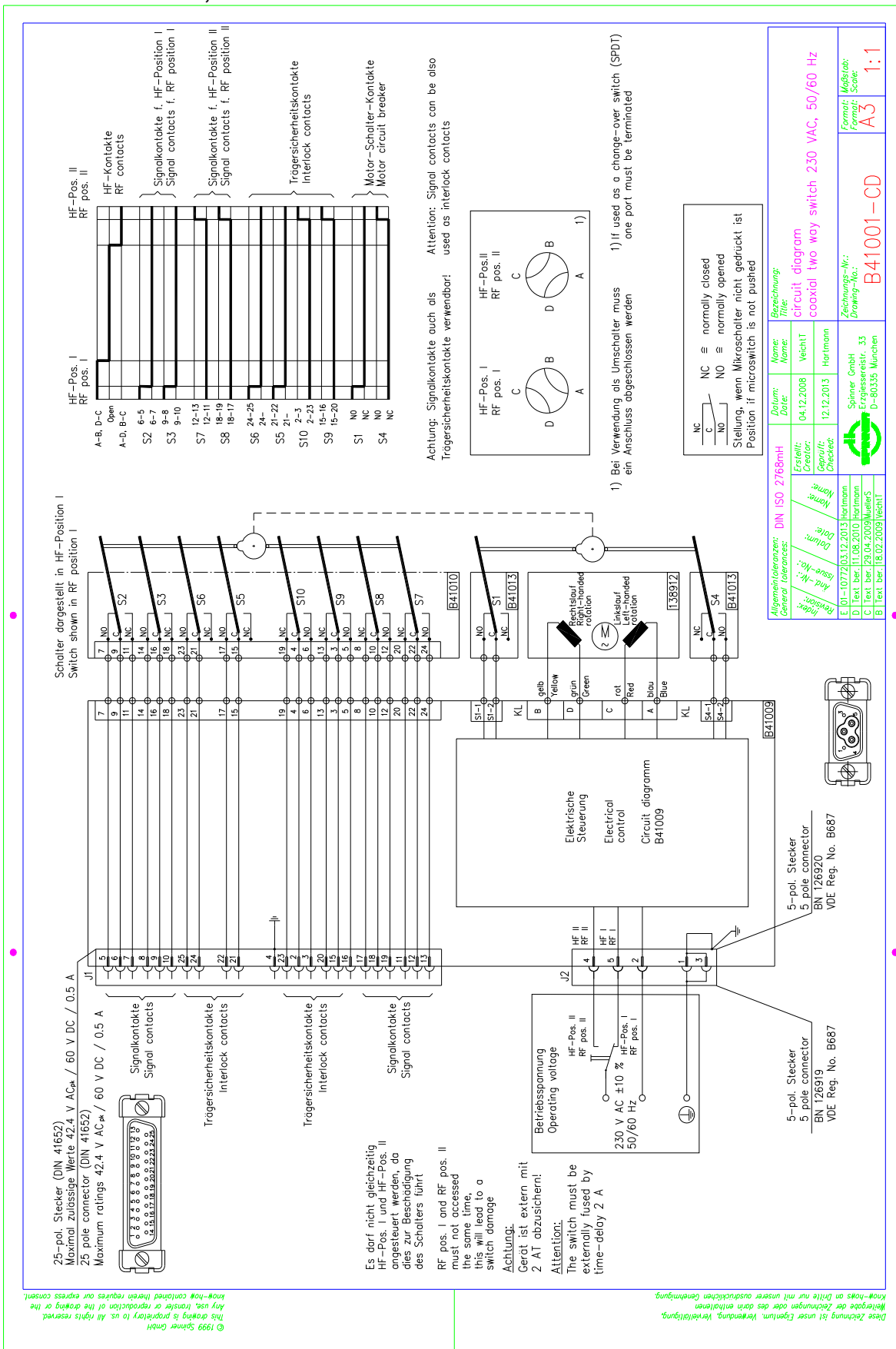

This drawing is proprietary to us. All rights reserved.  
Any use, transfer or reproduction of the drawing or the know-how contained therein requires our express consent.  
© 1999 Spinner GmbH

Dieses Zeichnung ist unser Eigentum. Verwendung, Weiterleitung, Weitergabe der Zeichnungen oder des darin enthaltenen Know-hows an Dritte nur mit unserer ausdrücklichen Genehmigung.  
This drawing is proprietary to us. All rights reserved.  
Any use, transfer or reproduction of the drawing or the know-how contained therein requires our express consent.

<b>DIN ISO 2768mH</b> Präzision: <b>2768mH</b> Name: <b>2768mH</b>		<b>Titel:</b> Name: <b>circuit diagram</b> Datum: <b>04.12.2008</b> Version: <b>1</b>		<b>Zeichnungs-Nr.:</b> Name: <b>B41001-CD</b> Datum: <b>12.12.2013</b> Version: <b>1</b>	
<b>Hersteller:</b> Name: <b>Spinner GmbH</b> Datum: <b>11.08.2010</b> Version: <b>5</b>		<b>Erzeuger:</b> Name: <b>Erzeugerstr. 33</b> Datum: <b>29.04.2009</b> Version: <b>5</b>		<b>Format:</b> Name: <b>A3</b> Datum: <b>18.02.2009</b> Version: <b>1</b>	
<b>Material:</b> Name: <b>coaxial two wcy switch 230 VAC, 50/60 Hz</b> Datum: <b>04.12.2008</b> Version: <b>1</b>		<b>Check:</b> Name: <b>Horstmann</b> Datum: <b>12.12.2013</b> Version: <b>1</b>		<b>Form:</b> Name: <b>1:1</b> Datum: <b>18.02.2009</b> Version: <b>1</b>	

## 8. Storage

Keep dry and avoid exposure to sudden temperature changes to prevent condensation. Environmental conditions for storage are specified in the data sheet of this manual. Do not unpack until immediately prior to installation.

## 9. Transportation



Before you start, ensure to read and understand the attached Basic Safety Instructions and the additional safety instructions on personal safety that appear in relevant parts of this manual.



### WARNING

Crushing hazard

Falling objects may cause death and serious injury.  
Use suitable lifting gear and means of transportation.  
Secure the cardboard against tipping or falling.  
Do not stand below the RF plug-in switch.  
Safety shoes are required.



### CAUTION

Sharp edges

Sharp edges may cause cuts and needle stick injuries.  
Use safety gloves and handle carefully.

Use suitable transportation and lifting gear approved to carry at least 10 kg. Do not unpack until immediately prior to installation.

## 10. Installation



Before you start, ensure to read and understand the Basic Safety Instructions and the additional safety instructions on personal safety that appear in relevant parts of this manual. Failure to observe could result in death or serious injury. Only trained electricians should install SPINNER RF plug-in switches in accordance with applicable national and international safety rules and regulations.

### WARNING

Electric shock hazard

Electric shock can cause severe burns and fatal injuries.

Before you start ensure to disconnect your entire system from the power supply.  
Utilize appropriate devices and methods to prevent accidental energizing.  
Do not damage or modify cables and connectors.

The mains connector must be de-energized during plugging.

The RF plug-in switch is not equipped with separating equipment for safe disconnection from mains. The user must provide external separation equipment.





**WARNING**

Radio frequency hazard  
 Radio frequency power can cause burns, eye injuries and electric shock. Before you start, ensure to disconnect your entire system from the power supply. Utilize appropriate devices and methods to prevent accidental energizing. Do not use the interlock loop for personal protection.



**WARNING**

Crushing hazard  
 Falling objects may cause death and serious injury. The RF plug-in switch is heavy. Use suitable lifting gear and means of transportation.



Secure the RF plug-in switch against tipping or falling until it is securely fixed to the patch panel. Safety shoes are required. If it is necessary to stand below the RF plug-in switch during installation, safety shoes and hardhat are required.



**CAUTION**

Sharp edges  
 Sharp edges may cause cuts and needle stick injuries. Use safety gloves and handle carefully.

**ATTENTION** The supplied packaging is reusable and required for transportation. Do not damage or dispose of the packaging.

**10.1 Mechanical and RF installation**

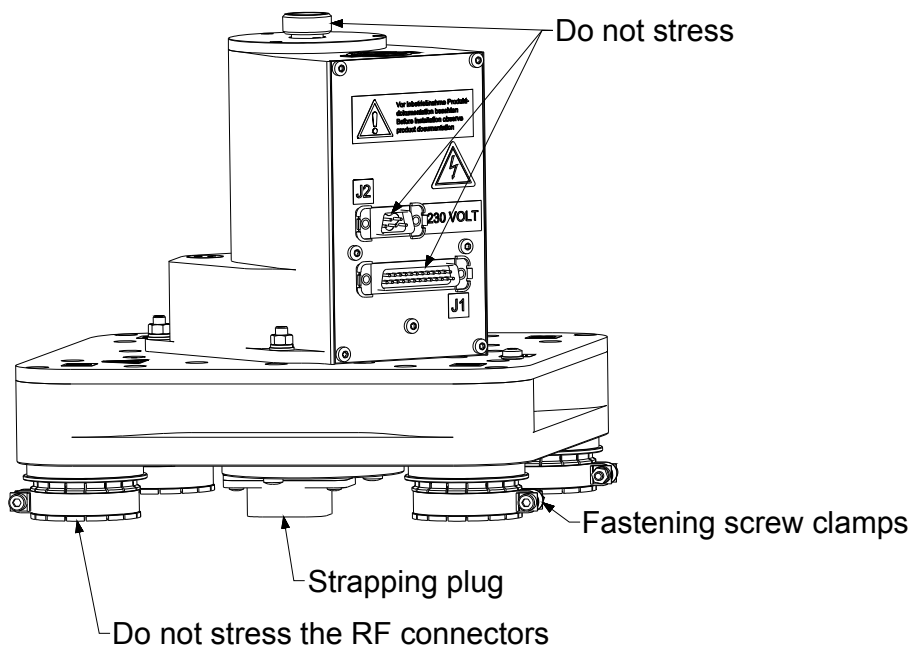

Use transportation and lifting gear approved to carry at least 10 kg only. Do not stress the connectors and the manual override.

- Remove any dirt or metallic particles on contact surfaces before connecting.
- Align the system connectors carefully with the RF plug-in switch to avoid scratches on the contacts.
- Push the RF plug-in switch carefully onto the patch panel until stop. Ensure sufficient strength of all RF connections.
- Depending on installation position, secure the RF plug-in switch against falling (e.g. by means of a second person) till the screw clamps are correctly tightened.
- Use a torque wrench to tighten all screw clamps of the connectors free of stress to 2.5 Nm  $\pm$ 5%.

**ATTENTION** Do not clamp the RF plug-in switch on the casing.

- Terminate all unused ports.

## 10.2 Electrical installation

**ATTENTION** Do not use the interlock loop for operational switch-off of the transmitters. Connect all transmitters to the interlock loop to avoid RF plug-in switch damage. Hot switching is not permitted.

- Follow the circuit diagram given in this manual and use the supplied connectors only to connect interlock, signal and mains.
- To ensure equipotential bonding with other plant components, connect the marked earthing terminal to the main earthing busbar with a copper lead (min 6 mm<sup>2</sup>).
- The interlock and signal contacts and the contacts of strapping plug for USL-Interlock I comply with the requirements for SELV (DIN EN 60950-1).  
The maximum permissible voltage is 42.4 V AC<sub>pk</sub> / 60 V DC. This applies to the loop voltage and the voltage between signal or interlock contacts and to the earthed casing. Limit the circuits externally by means of fuses to 0.5 A.
- Use a suitable and amply dimensioned power cord (min 0.5mm<sup>2</sup>, max 0.75mm<sup>2</sup>) and the supplied 5 pole connector BN 126919 only to connect power. Limit the power connection by means of an external fuse (time-delay, 2 A).
- Relieve all connections to the RF plug-in switch from any bending torque, e.g. caused by heavy cables or assemblies. Avoid sharp bends and tensile load.



## Installation of the 5 pole mains cable connector BN 126919

### Instructions for cable connection

#### 1. Removing of the protective housing

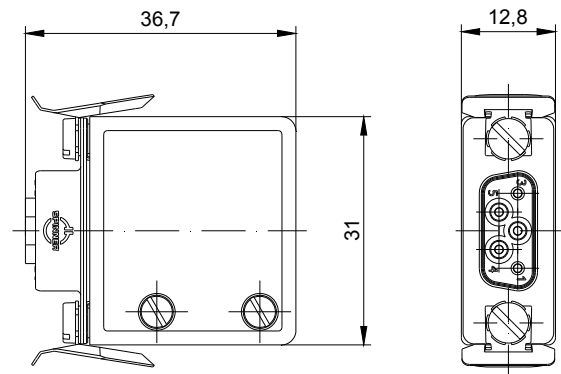
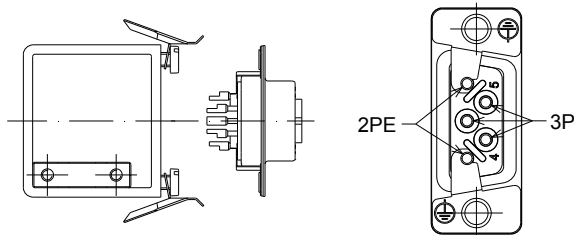

#### 2. Trimming of the cable strands



3.  
3.a Placing of the three heat shrinks (pins 2/4/5)  
3.b Soldering of the five cable strands

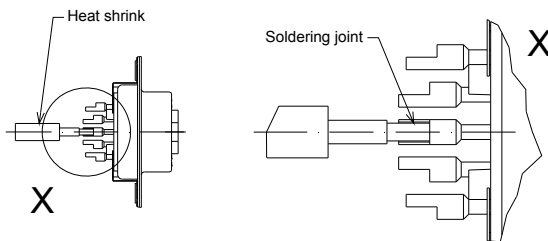

4.  
4.a Shrinking three heat shrinks (pins 2/4/5)  
4.b Assembling of the protective housing

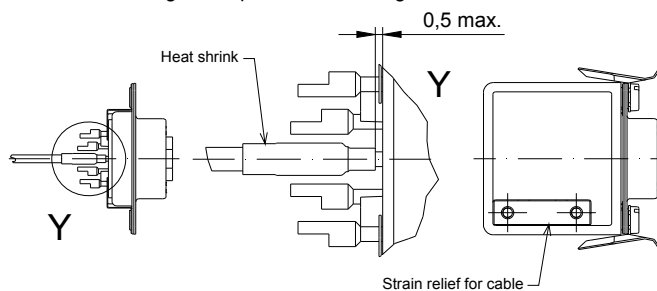

### Technical data

5 pole cable socket	Without breaking capacity
Rated voltage	250 V AC
Rated current	2 A
Rated impulse voltage	2.5 kV
Number of poles	3P + 2PE
Kind of termination	Solder termination
Cross section area	Max. 0.75 mm <sup>2</sup> / min. 0.50 mm <sup>2</sup>
Values for cable clamp	Ø 6 mm to Ø 8 mm
Temperature range	-25 °C to +85 °C
Operation cycles	10
Degree of protection	IP 20 according to IEC EN 60529
Degree of pollution	2
Max. altitude above sea level	4000 m / 13,120 ft according to IEC EN 60664-1
Heat shrink above pins 2/4/5	
Certified according to	VDE-Reg.-No. B687 DIN EN 61984: 2009-11; EN 61984: 2009
Approved plug connector	BN 126920

**Please attend the valid safety rules for assembling!**

Design is subject to change without notice

## 11. Commissioning



Before you start, ensure to read and understand the Basic Safety Instructions and the additional safety instructions on personal safety that appear in relevant parts of this manual. Failure to observe could result in death or serious injury. Only trained electricians should commission SPINNER RF plug-in switches.



### **WARNING**

Electric shock hazard

Electric shock can cause severe burns and fatal injuries.

Check proper connection and condition of all system connectors and cables prior to commissioning. The power connector must be de-energized during plugging.



### **WARNING**

Radio frequency hazard

Radio Frequency Power can cause burns, eye injuries and electric shock.

Check sufficient strength of all RF connections prior to commissioning.

Unused ports must be terminated. Check proper functioning of the interlock loop prior to commissioning.

## 12. Operation



### **CAUTION**

Risk of burns, cuts and needle stick injuries

Touching the manual override during electrical switching may cause injuries.

Do not touch the manual override during electrical switching.



### **CAUTION**

Hot surface

The RF plug-in switch heats up during normal operation. Touching it may cause burns. Do not touch the RF plug-in switch while hot. Wait until completely cooled off. The operator must control the access to the hazardous area.

**ATTENTION** Switch off all transmitters before actuating the RF plug-in switch to avoid RF plug-in switch damage. Hot switching is not permitted.

**ATTENTION** Do not block the manual override during electrical switching to avoid overheating and RF plug-in switch damage.

**ATTENTION** Do not place any heat-generating devices such as radiators or fan heaters near to the RF plug-in switch to avoid overheating and RF plug-in switch damage.

## 13. Cleaning

Periodic cleaning of the mounted RF plug-in switch is not required. Use a soft, but not damp duster, if cleaning of the demounted RF plug-in switch is required. Do not use compressed air.



### **WARNING**

Electric shock hazard

Electric shock can cause severe burns and fatal injuries.

Do not use any cleaning fluid to avoid the risk of serious injury at re-commissioning.

**CAUTION**

Hot surface

The RF plug-in switch heats up during normal operation. Touching it may cause burns. Do not touch the RF plug-in switch while hot. Wait until completely cooled off.

**14. Maintenance**

Periodic maintenance is not required. Carry out at least one switching cycle annually to avoid jamming. If the switch was not actuated for a period longer than one year (e.g. storage) carry out several switching cycles before applying RF power.

**15. Repairs**

Repairs may only be executed by the manufacturer or technical personnel authorized by the manufacturer.



Do not open the RF plug-in switch to avoid the risk of electric shock, high-frequency radiation and serious injury.

**CAUTION**

Hot surface

The RF plug-in switch heats up during normal operation. Touching it may cause burns. Do not touch the RF plug-in switch while hot. Wait until completely cooled off.

**16. Warranty**

Do not disassemble the RF plug-in switch. The warranty is void, if the RF plug-in switch is modified, improperly handled or third party intervention or modification has occurred.

**17. Demounting**

Before you start, ensure to read and understand the Basic Safety Instructions and the additional safety instructions on personal safety that appear in relevant parts of this manual. Failure to observe could result in death or serious injury. Only trained electricians should demount SPINNER RF plug-in switches.

**WARNING**

Electric shock hazard

Electric shock can cause severe burns and fatal injuries.

Before you start ensure to disconnect your entire system from the power supply.

Utilize appropriate devices and methods to prevent accidental energizing. Unplug power and interlock connector in de-energized condition.

**WARNING**

Radio frequency hazard

Radio Frequency Power can cause burns, eye injuries and electric shock.

Before you start, ensure to disconnect your entire system from the power supply.

Utilize appropriate devices and methods to prevent accidental energizing.



**CAUTION**

Hot surface

The RF plug-in switch heats up during normal operation. Touching it may cause burns. Do not touch the RF plug-in switch while hot. Wait until completely cooled off.

**WARNING**

Crushing hazard

Falling objects may cause death and serious injury.

Use suitable lifting gear and means of transportation. Secure the RF plug-in switch against tipping or falling.



Safety shoes are required. If it is necessary to stand below the RF plug-in switch during demounting, safety shoes and hardhat are required.

**CAUTION**

Sharp edges

Sharp edges may cause cuts and needle stick injuries.

Use safety gloves and handle carefully.

**ATTENTION** The supplied packaging is reusable and required for transportation. If not available, contact SPINNER before starting demounting.

Use transportation and lifting gear approved to carry at least 10 kg only. Do not stress the connectors and the manual override.

- Follow the procedure described in chapter 10 in reverse order.

## 18. Disposal



The user is responsible for disposing of the RF plug-in switch in accordance with the national waste disposal regulations. Improper disassembly or disposal may be hazardous!

## 19. Additional endangering (regardless to life cycle)

**WARNING**

Lightning hazard

Lightning may cause electric shock, burns and serious injury.

Use suitable overvoltage protection to ensure that no overvoltage (such as that caused by a bolt of lightning) can reach the product. Use a copper lead (min 6 mm<sup>2</sup>) to connect the marked earthing terminal to the main earthing busbar.

## 20. Environmental friendly usage period

表 1 有害物质名称及含量标识格式

Table 1 Marking Styles for the Names and Contents of the Hazardous Substances

Part Name 部件名称	Hazardous Substances 有害物质					
	Lead (Pb) 铅	Mercury (Hg) 汞	Cadmium (Cd) 镉	Hexavalent Chromium (Cr(VI)) 六价铬	Polybrominated biphenyls (PBB) 多溴联苯	Polybrominated diphenyl ethers (PBDE) 多溴二苯醚
Metal parts 金属零件	X	O	O	O	O	O

This table is prepared in accordance with the provisions of SJ/T 11364.  
本表格依据 SJ/T 11364 的规定编制。

O: Indicates that said hazardous substance contained in all of the homogeneous materials for this part is below the limit requirements of GB/T 26572.  
O: 表示该有害物质在该部件所有均质材料中的含量均在 GB/T 26572 规定的限量要求以下。

X: Indicates that said hazardous substance contained in at least one of the homogeneous materials used for this part is above the limit requirements of GB/T 26572.  
(Enterprises may further provide in this box technical explanation for marking "X" based on their actual circumstances.)  
X: 表示该有害物质至少在该部件的某一均质材料中的含量超出 GB/T 26572 规定的限量要求。  
(企业可在此处, 根据实际情况对上表中打 "X" 的技术原因进行进一步说明。)

## 21. Spare parts

Designation	Order-No.	Qty.
Mains cable connector (J2, 5 pole)	BN 126919	1
Interlock/signaling cable connector (J1, 25 pole)	BN 122886	1

## 22. Accessories (not in delivery)

Designation	Order-No.	Qty.
Interlock support for USL-interlock I (J3, 8 pole)	BN 539145	1

## 23. Contacts

### **SPINNER GmbH • Headquarters**

Erzgiessereistr. 33  
80335 München  
Germany

Phone +49 8912601-0  
E-mail: [info@spinner-group.com](mailto:info@spinner-group.com)  
Web: [www.spinner-group.com](http://www.spinner-group.com)

### **Spinner Telecommunication Devices (Shanghai) Co., Ltd**

351 Lian Yang Road  
Songjiang Industrial Zone  
Shanghai 201613  
China

Phone +86 21 5774 5377  
E-mail: [info-china@spinner-group.com](mailto:info-china@spinner-group.com)  
Web: [www.spcn.cn](http://www.spcn.cn)