





SPINNER || PRODUCT MANUAL

A decorative graphic consisting of two overlapping rectangular blocks. The left block is a solid dark gray, and the right block is a lighter gray with a radial gradient, appearing to glow from the center.

Original instructions
Dummy Load
25 kW

A decorative graphic consisting of three overlapping rectangular blocks. The left block is a solid dark gray, the middle block is a medium gray, and the right block is a light gray with a radial gradient, appearing to glow from the center.

RF Interface
3 1/8" EIA

BN 546404C0200
BN 546404C0201

A decorative graphic at the bottom of the page, featuring a wavy, grid-like pattern of small dots that creates a sense of depth and movement, resembling a stylized wave or a mesh structure.

High Frequency Performance Worldwide

www.spinner-group.com

Content

1	Safety	3
1.1	About this product documentation.....	3
1.2	Intended use.....	3
1.3	Improper use	3
1.4	Qualifications of personnel.....	3
1.5	Safety signs and symbols	4
1.6	Signal words for hazard seriousness	4
1.7	Grouped safety messages for SPINNER broadcast products	5
2	Product identification	7
3	Function.....	7
3.1	General.....	7
3.2	Coolant	7
3.3	Heat exchanger	8
3.4	Coolant circuit of the liquid cooling system	8
3.5	Interlock loop	9
3.6	Operating and display elements.....	10
3.7	Maintenance cycle.....	10
4	Storage.....	10
5	Transportation	11
6	Installation	12
6.1	Mechanical installation	12
6.2	Coolant level check and drain hose installation	14
6.3	Electrical installation.....	14
7	Commissioning and normal operation.....	16
8	Cleaning	17
9	Maintenance.....	17
9.1	PLC clock time setting.....	17
9.2	Deaeration of the cooling circuit.....	18
9.3	Checking glycol concentration	20
9.4	Correcting the coolant level.....	21
9.5	Front panel fan filter cleaning.....	22
10	Warranty.....	22
11	Repairs	22
12	Demounting	23
13	Disposal.....	24
14	Spare Parts	24
15	Contacts	25
16	Attachments	25

1 Safety

1.1 About this product documentation

The Spinner group makes every effort to keep the safety standard of our products up to date to be able to offer our customers the highest possible degree of safety. Our products are designed and tested in accordance with the relevant safety standards. There is, however, still a danger of personal injury or damage to equipment if this chapter and the safety instructions in this documentation are not complied with. This documentation aims at persons commissioned with the transport, installation, commissioning, operation, cleaning, maintenance, repairs, demounting and disposal of SPINNER dummy loads. Read this documentation completely and particularly the chapter "Safety", before working with the product. Keep this product documentation available at the site and pass it on to the subsequent users. For all questions regarding the safety you can contact SPINNER at any time.

1.2 Intended use

The intended use of the product is to terminate RF high power coaxial transmission lines. The dummy load BN 546404C0200 and BN 546404C0201 is designed to absorb RF power of max. 25 kW in broadcast or industrial indoor applications in operating rooms with restricted access. Access for authorized persons shall be regulated by the operator.

Details and other limits are given in the attached data sheet 546404C0200-BE.

The intended use of the product is assumed, if it is used in accordance with the requirements of the applicable product documentation and within its performance limits (see appendices data sheet, circuit diagram, material data sheet of the SPINNER coolant and the following safety instructions). Applicable local or national safety regulations and rules for the prevention of accidents must be observed in all work performed in conjunction with the product.

1.3 Improper use

The improper use of the product involves the use of the product:

- in operating rooms with unrestricted access
- in outdoor applications
- in explosion-prone atmosphere
- for transporting people or loads
- without correctly connected interlock system
- with covered inlet or exhaust air openings
- with modifications not authorized by SPINNER
- in damaged condition
- for private purposes
- in conditions and environments beyond the limits given in this product documentation

Any other use than described in the chapter intended use and in this product documentation is improper use and therefore inadmissible.

1.4 Qualifications of personnel













Installation, commissioning, operation, maintenance, repairs and demounting of the product require electrical and mechanical specialized knowledge. In order to ensure the safe use, these activities may therefore only be carried out by qualified technical personnel or an instructed person under the direction and supervision of qualified personnel. Qualified personnel are those who, due to professional training, knowledge and experience as well as their understanding of the relevant regulations, are able to assess the work assigned, to recognize possible hazards and to institute appropriate safety measures.

Qualified personnel must have appropriate safety equipment and must be trained in first aid.

The use of the product requires special training and a high level of concentration. It must be ensured that persons who use the product are physically, mentally and emotionally able to comply with the requirements, otherwise injuries or material damage may occur. The employer or operator must choose suitable personnel for use of the product.

1.5 Safety signs and symbols

Safety signs are used on warning labels, stickers, in the product documentation and on the packaging of the product.

					
Warning! General hazard	Warning! Danger of electric shock	Warning! Hot surface	PE terminal	Earth	Warning! High weight
					
Warning! Non-ionised electromagnetic radiation	No access for persons with pacemakers	Use safety shoes	Use safety helmet	Use safety gloves	Observe product documentation

1.6 Signal words for hazard seriousness

Signal words are used on warning labels, stickers, in the product documentation, on specific danger spots and on the packaging of the product. They indicate the hazard seriousness in safety messages.

- DANGER** Indicates a hazardous situation conveying great risk which, if not avoided, will result in death or serious injury.
- WARNING** Indicates a hazardous situation conveying moderate risk which, if not avoided, could result in death or serious injury.
- CAUTION** Indicates a hazardous situation conveying minor risk which, if not avoided, may result in minor or moderate injury.
- NOTICE** Indicates the possibility of faulty operation that can damage the product.

It is essential to make sure that the signal words described here are always used only in connection with the related product documentation and the related product. The use of signal words in connection with unrelated products or documentation can result in misinterpretation and thus contribute to personal injury or material damage.

1.7 Grouped safety messages for SPINNER broadcast products

Entire or multiple phases of product lifecycle

- Unless otherwise specified, these products are not protected against penetration of liquids, gases, steam, etc. Failure to comply could result in electric shock or product damage, which could also lead to serious injury.
- Blocking of constructive openings on the product (ventilation slots, fine leaks etc.) must be prevented, because these are necessary for product operation. Failure to comply could lead to overheating and could result in burns, fire and electric shock.
- Any object that is not designed to be placed in the openings of the housing must not be used for this purpose. Doing so can cause short circuits inside the product and could result in electric shock, fire or injury.
- Depending on the function, certain products such as RF radio equipment can produce an elevated level of electromagnetic radiation. Considering that unborn babies require increased protection, pregnant women must be protected by appropriate measures. Persons with pacemakers may also be exposed to risks from electromagnetic radiation. The employer/operator must evaluate workplaces where there is a special risk of exposure to radiation and, if necessary, take measures to avert the potential danger.
- As with all industrially manufactured goods, the use of substances that induce an allergic reaction (allergens) such as nickel cannot be generally excluded. If you develop an allergic reaction (such as a skin rash, frequent sneezing, red eyes or respiratory difficulties) when using a SPINNER product, consult a physician immediately to determine the cause and to prevent health problems or stress.
- Should a fire occur, the product may release hazardous substances (gases, fluids, etc.) that can cause health problems. Therefore, suitable measures must be taken, e.g. protective masks and protective clothing must be worn.

Transport

- The product may be very heavy. In some cases, the user may require suitable lifting gear and means of transportation to avoid back or other physical injuries.
- Transport the product only in the original packaging. Do not unpack until immediately prior to installation. Failure to comply could result in death or serious injury.

Installation

- Do not place the product on heat-generating devices such as radiators or fan heaters. The ambient temperature must not exceed the maximum temperature specified in the product documentation or in the data sheet. Product overheating could result in burns, fire and electric shock.
- Do not place the product on surfaces, vehicles, cabinets or tables that for reasons of weight or stability are unsuitable for this purpose. Always follow the installation instructions of the manufacturer when installing the product and fastening it to objects or structures (e.g. walls and shelves). An installation that is not carried out as described in the product documentation could result in death or serious injury.
- Mains driven products must be operated only from a TN power distribution system. The operator is responsible for using an appropriate and sufficiently dimensioned AC power line. The AC power line must be externally fused according to the product documentation. Failure to comply could result in fire or electric shock.
- Operation of products with protection class I according to EN 61140 is permitted only with a mains cable with protective earth connection. The protective conductor continuity must be inspected by an electrically skilled person. Failure to comply could result in electric shock.

- All externally connected circuits for controlling, alerting and signalling have to be fed from SELV sources acc. to DIN EN 60950-1 only. The current in these circuits has to be externally limited by means of fuses to values indicated in the product documentation. Failure to comply could result in fire and electric shock.
- Dangerous voltage must not reach the product over the outer conductor/waveguide. Failure to comply could result in electric shock.
- If the product is equipped with a ground terminal connection (equipotential connection), the ground terminal must be connected sufficiently dimensioned to earth. Failure to comply could result in electric shock.

Commissioning / Operation

- Products in operation may be hot. Touching them could result in burns.
- Before applying RF-power to the product, ensure proper connection and matching (load, line, etc.) of all RF-connectors. Ensure sufficient mechanical rigidity of the RF-connections. Failure to comply could result in serious injuries by non-ionised electromagnetic radiation.
- Operation of the product with a damaged cable is not permitted. All cables must be checked on a regular basis to ensure that they are in proper operating condition. By taking appropriate safety measures and carefully laying the power cable, ensure that the cable cannot be damaged and that no one can be hurt or suffer an electric shock by e.g. tripping over the cable.
- Front panels, lids and covers must not be removed during operation. Otherwise, live components can be accessible. This could result in electric shock, fire and serious injury.
- If the product is subjected to pressure, the locally and nationally applicable guidelines for pressure vessels must be applied. Failure to comply could result in death or serious injury.

Cleaning

- Prior to cleaning, turn off all feeding transmitters and disconnect them from the power supply. Use a soft, lint-free, dry cloth for cleaning. Do not use chemical cleaners. Perform cleaning only after cooling-down. Failure to comply could result in electric shock and burns.

Repair

- Troubleshooting and repairs should only be carried out by qualified technical personnel or an instructed person under the direction and supervision of qualified personnel (see chapter 1.4 "Qualifications of personnel"). Observe the section safety messages and in particular chapter 1 "Safety" of this product manual. Failure to comply could result in death or serious injury.
- Do not modify the product and use only spare parts tested and approved by SPINNER. Failure to comply could result in death or serious injury.

Disposal

- The operator is responsible for disposing of the product according to national waste disposal regulations. Improper disassembly or disposal may be hazardous.
- If hazardous substances or operation materials are used for operation of the product, which must be periodically disposed of (e.g. coolant), these materials must be treated in accordance with the safety instructions of the hazardous substance or operating material manufacturer and the national waste disposal regulations. Also observe the relevant safety instructions in this product documentation. Failure to comply could result in serious injury and environmental damage.

2 Product identification

The SPINNER dummy loads BN 546404C0200 or 546404C0201 have a type plate containing the following information for product identification:

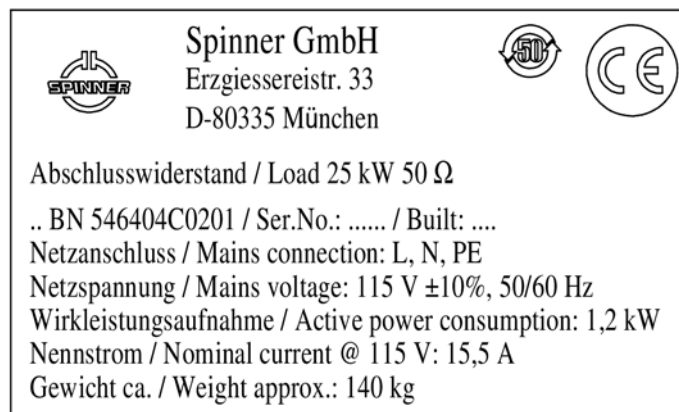
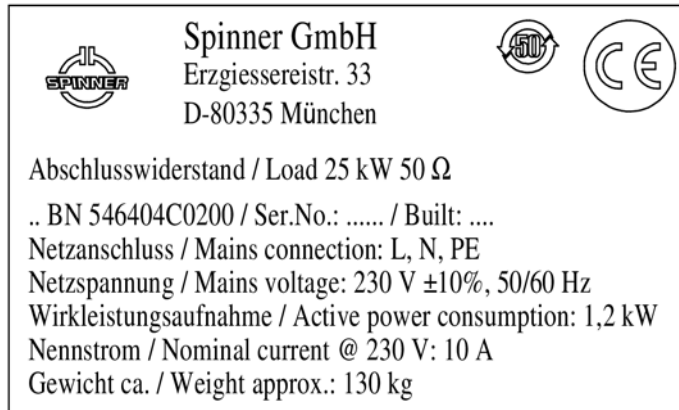

3 Function

3.1 General

The resistor element of the dummy load, consisting of a cylindrical ceramic substrate coated with special resistive material, absorbs the RF power and converts it into heat. An unpressurized liquid cooling system with coolant pump and closed cooling circuit is used for transferring the heat from the resistor element, via a heat exchanger with forced air cooling, to the surrounding area.

3.2 Coolant

The coolant ANTIFROGEN N is a well-balanced yellow coloured mixture of distilled water, ethylene glycol and a rust preventative. The composition ensures excellent protection against corrosion and freezing. The coolant is available in 30 litres containers (SPINNER BN A74423).



Observe the material data sheet of the coolant when filling up, emptying or deaerating the cooling system or disposing of the coolant.

3.3 Heat exchanger

A radiator fan is used for re-cooling of the heat sink.

NOTICE Ensure unobstructed air circulation to avoid overheating.

3.4 Coolant circuit of the liquid cooling system

A pressureless closed cooling circuit with radiator fan is used for heat release. The coolant is pumped through the resistor element W and the heat exchanger K by means of the coolant pump P. The expanse vessel AB is added due to the thermal expansion of the coolant. The outer surface temperature of the resistor element and the coolant temperature are monitored by means of the temperature controllers B1 and B2.

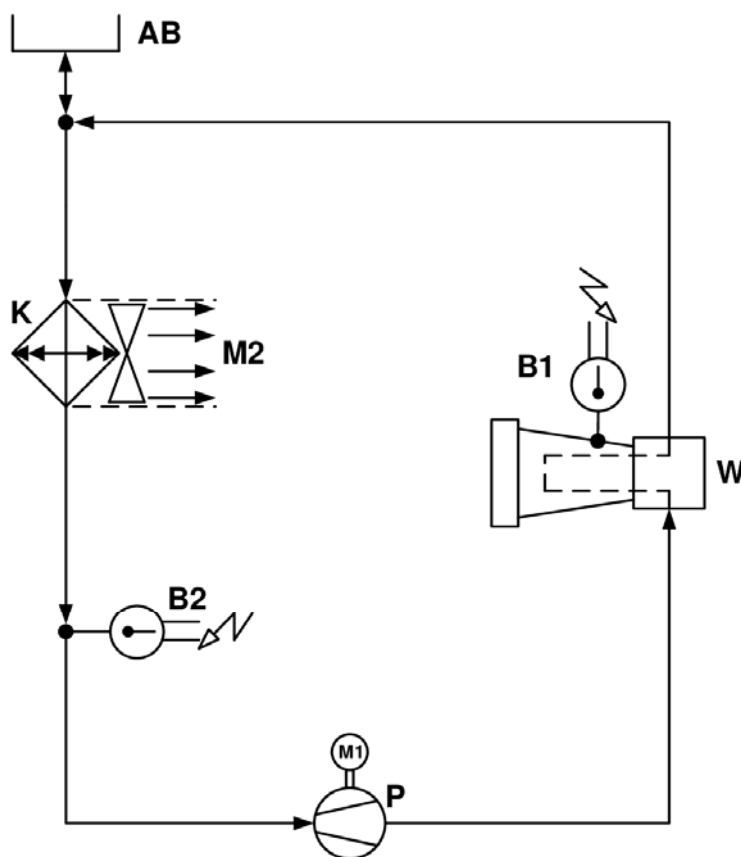

- AB: Expanse vessel
- B1: Temperature controller resistor
- B2: Temperature controller coolant
- K: Heat exchanger
- M1: Motor coolant pump
- M2: Radiator fan (Heat exchanger)
- P: Pump
- W: Resistor element

3.5 Interlock loop

The internal interlock loop for protection of the dummy load consists of a programmable logic controller (PLC), temperature controllers and signal contacts. In principle the PLC works like five in series connected switches which are all closed during normal operation of the dummy load. Any open switch shuts down all transmitters connected to the interlock loop.

- The temperature controller B1 opens at resistor temperatures above 275 °C and closes below 250 °C.
- The temperature controller B2 opens at coolant temperatures above 90 °C and closes below 80 °C.
- The protection function of the frequency inverter FU1 for the coolant pump motor M1 opens at coolant pump motor overload.
- The protection function of the frequency inverter FU2 for the ventilator motor M2 opens at ventilator motor overload.
- The main switch interlock is open in power off position of the main switch.



WARNING

Electric shock hazard
 Electric shock can cause severe burns and fatal injuries.
 Do not use the interlock loop for personal protection

Schematic diagram of the switching status during normal operation:

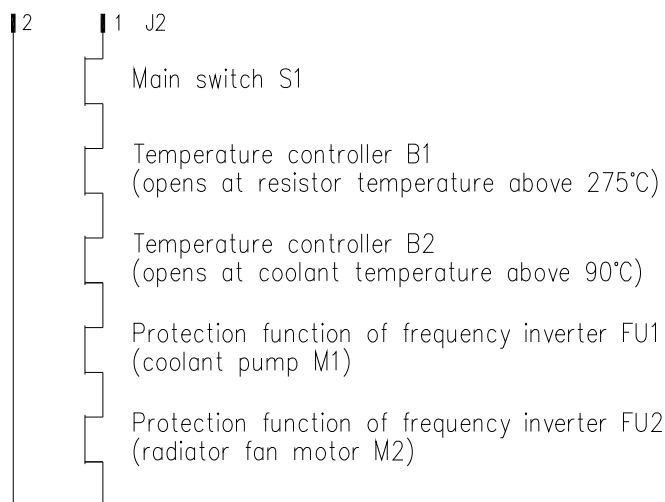

The internal interlock loop complies with the requirements for Safety Extra Low Voltage (SELV according to DIN EN 60950-1, safe separation, proof voltage resistance 3 kV AC to primary circuit).

The maximum permissible voltage for the interlock loop and to the grounded housing is 42.4 V ACpk respectively 60 V DC. The power supply must be fully compliant with the SELV requirements. The circuit has to be limited externally to 1 A.

3.6 Operating and display elements

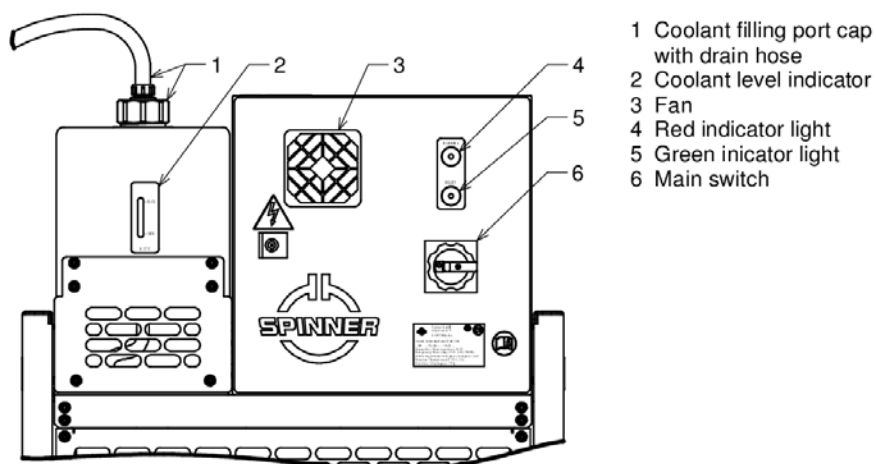

Green indicator light “READY“:

Some 10 seconds after main switch turned on, the green light indicates readiness for operation:

- Mains voltage is connected
- Main switch is turned on
- No fault occurred

Red indicator light “WARNING“:

The red light indicates that the interlock loop of the load is interrupted. All transmitters connected properly to the interlock loop are turned off.

The red indicator lamp lights, if the mains voltage is connected and the main switch is turned on and at least one of the following four conditions is true:

- Resistor element temperature too high
- Coolant temperature too high
- Motor protection FU 1 triggered
- Motor protection FU 2 triggered

Front panel fan

The fan mounted on the front panel of the control cabinet is required for cooling of the frequency inverters FU1 and FU2. The fan runs if the pump is operating.

3.7 Maintenance cycle

To prevent the coolant pump from jamming, the PLC activates autonomous maintenance cycles weekly for the duration of a few minutes. One cycle starts every 7 days after the dummy load is switched on, another cycle starts at a specific time, refer to chapter 9.1 “PLC clock time setting”.

4 Storage

Keep dry and avoid exposure to sudden temperature changes to prevent condensation. Environmental conditions for storage are specified in the attached data sheet 546404C0200-BE. Do not unpack until immediately prior to installation.

NOTICE

Do not remove any connector protection cap until immediately prior to installation to avoid formation of dust and scratches on sensitive RF contact surfaces. Environmental conditions for storage see attached data sheet TD-00060

5 Transportation



CAUTION

Crushing Hazard

The dummy load is heavy. Crushing or falling may cause injuries.

Use suitable lifting gear approved to carry at least 150 kg.

Do not stand below the dummy load.

To ensure stability, keep the product in the supplied transport packaging until immediately prior to installation.

Do not lift the dummy load at the RF connector.

Do not stress the expense vessel and the control cabinet.

Safety shoes and hardhat are required.



NOTICE

Environmental conditions for transportation see attached data sheet TD-00060



do not stress

straps

do not stress



do not stress

do not stress

fixing straps

lock all swivel castors with double stop if present

6 Installation



Before you start, ensure to read and understand the section safety messages and in particular chapter 1 "Safety" of this product manual. Only electrically skilled persons should install SPINNER dummy loads in accordance with the national safety and accident prevention regulations.

Failure to observe could result in death or serious injury.

6.1 Mechanical installation



WARNING

Crushing Hazard

Falling objects may cause death and serious injury.

The dummy load is heavy. Use suitable lifting gear only. The lifting gear must be approved to carry at least 150 kg.

Do not lift the dummy load at the RF connector.

Do not stress the expandable vessel and the control cabinet.

Use suitable fasteners if mounted in an elevated position.

Safety shoes are required. If it is necessary to stand below the dummy load during installation, safety shoes and hardhat are required.



WARNING

Electric shock hazard

Electric shock can cause severe burns and fatal injuries.

Do not install and operate the dummy load in environmental conditions beyond the specifications given in the attached data sheet 546404C0200-BE. The dummy load is designed for indoor application on operating sites with limited access only.



Floor installation:

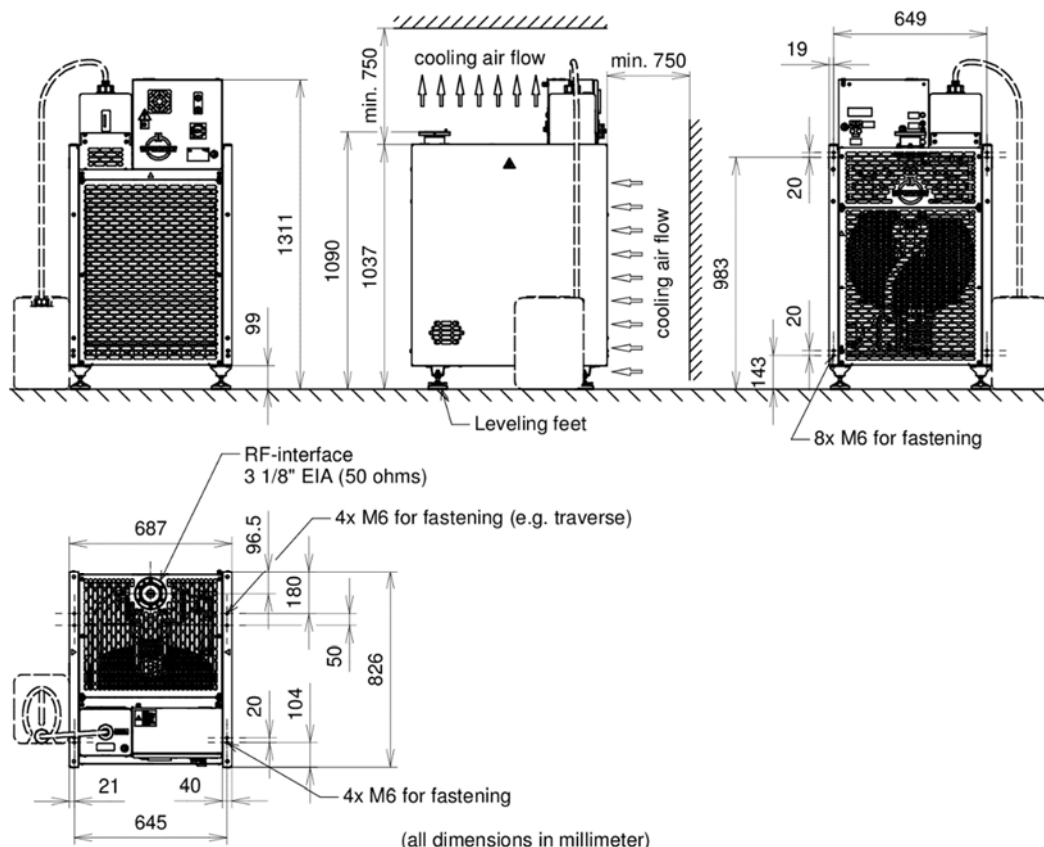

The dummy load must be installed on a flat and solid ground with bearing capacity higher than 150 kg to ensure stability. The front panel, main switch and filling port need to be easily accessible. Do not install the dummy load on escape routes, corridors or close to temperature sensitive equipment. Required floor space for best possible cooling capacity is specified in the installation drawing below. Slight unevenness of the floor can be compensated by means of the levelling feet. The load can be additionally fixed with the lower M6 mounting threads. The M6 threads near to the RF connector can be used for mounting a traverse to support the RF cable.

NOTICE Ensure unobstructed air circulation to avoid overheating.
Do not reduce the ground clearance if installed without levelling feet.

Ceiling installation:

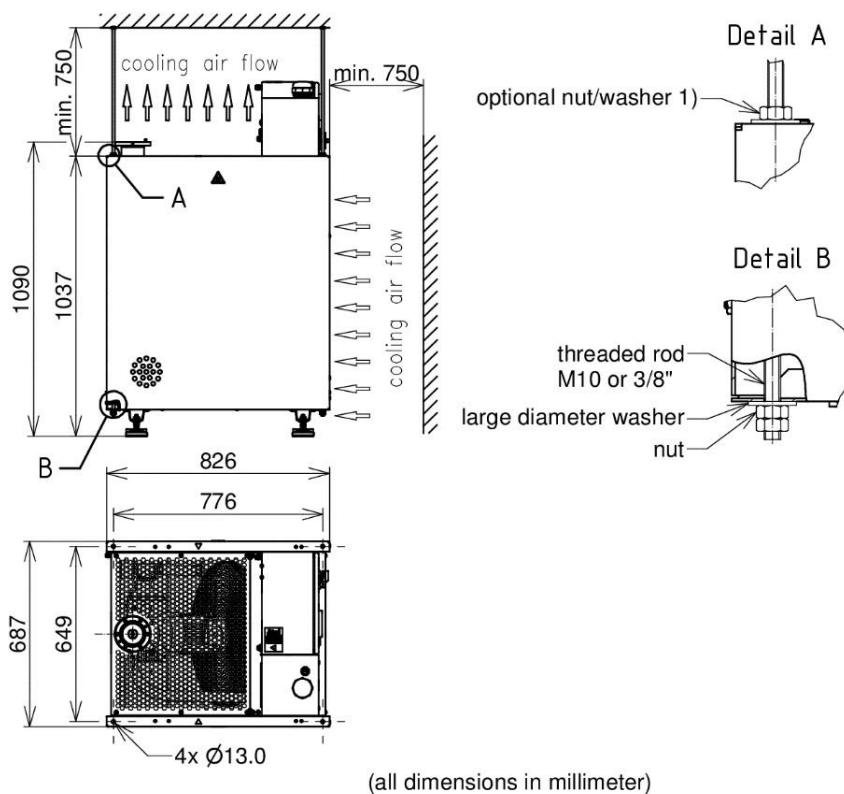

Pictures show fixing material exemplary.

- 1) To hold the threaded rod in position before ceiling mounting, a nut can optionally be attached to the top of the housing

The dummy load must be installed on a solid ceiling with bearing capacity higher than 150 kg to ensure stability. The front panel, main switch and filling port need to be easily accessible. Do not install the dummy load close to temperature sensitive equipment. Ensure sufficient pass line heights and the required cooling air flow space, refer to floor installation.

NOTICE Ensure unobstructed air circulation to avoid overheating.

Threaded rod through the housing: M10 or 3/8"
Tensile strength min. 400 N/mm²
Yield point min. 240 N/mm²

Recommended tightening torque for counter nut: 30 Nm

6.2 Coolant level check and drain hose installation

SPINNER supplies the dummy load with correct coolant level and deaerated cooling circuit. The dummy load is equipped with a level indicator. The marking indicates the minimum and the maximum permissible level of the coolant.

NOTICE The coolant level may exceed the marked maximum at temperatures above 25 °C.
Check the coolant level prior to commissioning.
Prevent dry running of the coolant pump.
Follow the instructions given in chapter 9.4 if correction of the coolant level is required.

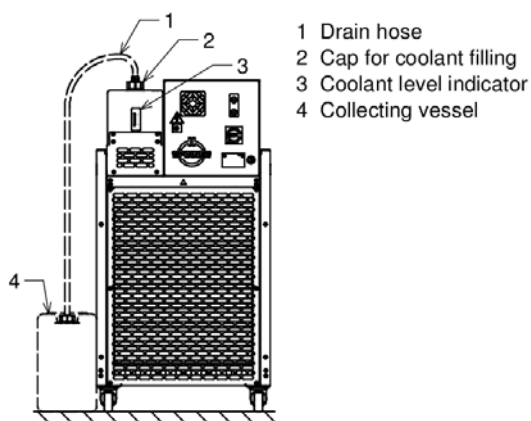

Connect the supplied drain hose (1) to the cap (2). Place a suitable collecting container (4) with a capacity of at least 3 litres next to the dummy load and insert the drain hose (1) into the collecting container (4). In the event of a malfunction with a sudden rise in pressure in the cooling circuit, escaping coolant is drained via the drain hose into the collecting container.

The expansion tank has a membrane for continuous adaptation to the ambient pressure.

6.3 Electrical installation



WARNING

Electric shock hazard
Electric shock can cause severe burns and fatal injuries.
Before you start ensure to disconnect your entire system from the power supply.
Utilize appropriate devices and methods to prevent accidental energizing.



WARNING

High leakage current
Connect at least 10 mm² PE conductor permanently to separate PE terminal before connecting mains connector.



WARNING

Radio Frequency Hazard
Radio Frequency Power can cause burns, eye injuries and electrical shock.
Before connecting the RF cable, ensure to disconnect your entire system from the power supply. Utilize appropriate devices and methods to prevent accidental energizing.

NOTICE

To avoid overheating caused by RF overload ensure to connect all relevant transmitters to the interlock system of the dummy load prior to commissioning.

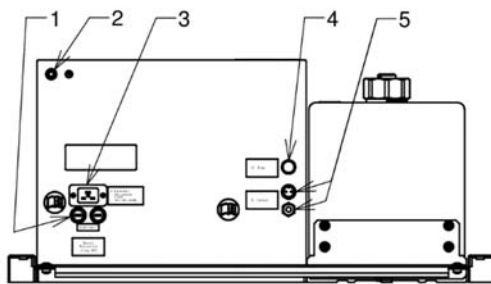

- 1 Mains inlet fuses (F2, F3)
- 2 PE terminal
- 3 Mains connection (J1)
BN 546404C0200: 230 V $\pm 10\%$; L, N, PE; 50/60 Hz
BN 546404C0201: 115 V $\pm 10\%$; L, N, PE; 50/60 Hz
- 4 Pushbutton for pump (S2)
- 5 Connection/cable gland for Interlock loop (J2)

- Connect a PE conductor of at least 10 mm² with cable lug permanently to marked separate PE terminal, either at the top of the switch cabinet (M8 screw) or at the bottom on the rear of the frame (M8 screw), before connecting any other wire.

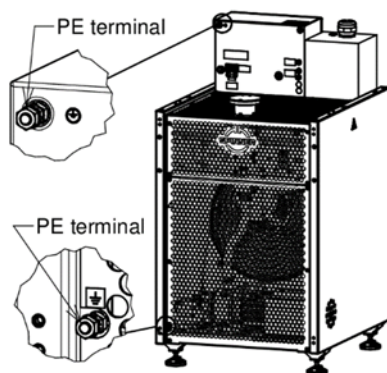

- Connect the interlock loop:
 - Option 1
Mount the supplied interlock loop connector on a suitable cable and attach the connector to the two-pole screw locking IEC 60130-9 port on the rear side of the control box
 - Option 2
Alternatively use the cable gland on the rear side of the control box to run the interlock cable to the terminals inside the control box in accordance with the attached circuit diagram 546404-CD-0E. Push a screwdriver into the rectangular opening of the clamp, insert the wire into the round opening and then pull out the screwdriver.

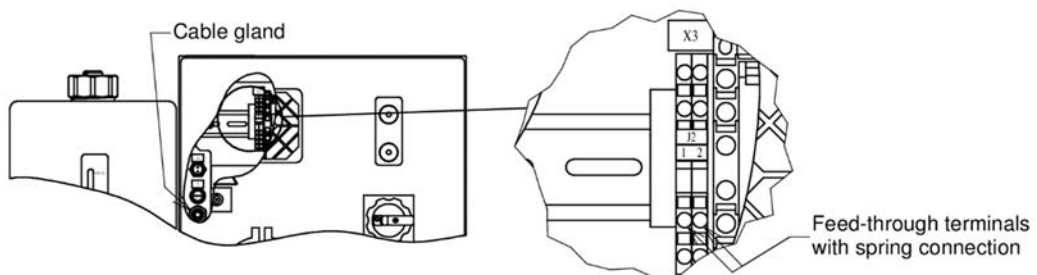

Check proper function of the interlock system prior to commissioning. Do not use the interlock loop for personal protection.

The maximum permissible voltage for the interlock loop and to the grounded housing is 42.4 V ACpk respectively 60 V DC. The power supply must be fully compliant with the Safety Extra Low Voltage requirements (SELV according to DIN EN 60950-1). The circuit has to be limited externally to 1 A

- Mount a suitable mains connector to the supplied IEC 60320-1 C19 socket power cord according to the attached circuit diagram.
Mains connector requirements:

BN 546404C0200 230 V AC, 50 Hz to 60 Hz, 10 A, 3x2.5 mm²

BN 546404C0201 115 V AC, 50 Hz to 60 Hz, 16 A, 3x2.5 mm²

Alternatively, a standard mains cable with a cross-section of 3x2.5 mm² and an IEC 60320-1 C19 socket can be used.

Use an easily accessible socket located close to the dummy load for mains connection.

Connect the dummy load only to TN networks (L, N, PE):

BN 546404C0200 230 V AC, 50 Hz to 60 Hz

BN 546404C0201 115 V AC, 50 Hz to 60 Hz

- Connect RF using connectors according to IEC 339 only.
- Relieve all connections to the dummy load from any bending torque, e.g. caused by heavy cables or assemblies.
- Check sufficiently dimensioned PE-connection and PE-continuity prior to commissioning.
- Check functioning of the interlock loop by turning the main switch (S1) into the off position.

7 Commissioning and normal operation



Before you start, ensure to read and understand the section safety messages and in particular chapter 1 "Safety" of this product manual. Only electrically skilled persons may commission and operate SPINNER dummy loads in accordance with the national safety and accident prevention regulations. Failure to observe could result in death or serious injury.

Before applying RF power to the dummy load electrically skilled persons have to ensure:

- proper connection of all system connectors
- proper functioning of the interlock loop, all relevant transmitters must be connected to the interlock system of the dummy
- unobstructed air circulation; do not cover the ventilation openings
- the dummy load is switched on; the green indicator lights

After each actuation of the main switch the pump runs a maintenance cycle of approx. 10 seconds.

NOTICE The maintenance cycle does not affect the operation, RF power can still be applied.

Open the switch cabinet and set, if applicable, the clock time and date as described in chapter 9.1.

During operation, the pump and fan switch on at intervals. The length of the intervals depends on the RF power applied and the ambient temperature.

8 Cleaning



Before you start, ensure to read and understand the section safety messages and in particular chapter 1 "Safety" of this product manual. Only trained persons may clean SPINNER dummy loads in accordance with the national safety and accident prevention regulations.

Failure to observe could result in death or serious injury.

WARNING

Electric shock hazard



Electric shock can cause severe burns and fatal injuries.

Before you start ensure to disconnect your entire system from the power supply. Utilize appropriate devices and methods to prevent accidental energizing.

Do not use any liquids for cleaning.

WARNING

Entanglement Hazard



The ventilators may entangle hair, clothing or jewelry causing death or serious injury.

Wait until all rotating parts have stopped.

Wear a hair net and close-fitting clothing.

CAUTION

Hot surface



The resistor element heats up during normal operation and may cause burns.

Do not remove any covers shortly after use of the dummy load.

Do not touch the resistor element before cooled-down

Use a soft, but not damp duster, if cleaning of the exterior housing surfaces is required. Remove dust or dirt from the heat exchanger with compressed air or a soft brush.

9 Maintenance

We recommend checking the coolant level as well as unobstructed air circulation of the heat exchanger every 6 weeks. Remove dust or dirt from the heat exchanger with compressed air or a soft brush.

9.1 PLC clock time setting



Before you start, ensure to read and understand the section safety messages and in particular chapter 1 "Safety" of this product manual. Only electrically skilled persons may open the control box of SPINNER dummy loads and set the PLC clock time in accordance with the national safety and accident prevention regulations.

To prevent coolant pump from becoming jammed, the PLC activates an autonomous maintenance cycle weekly on Fridays at 8:00 am for the duration of a few minutes. If there is a power outage of the PLC for more than 20 days, on restarting, the internal clock is back in the status that it was in before the power outage. An automatic summer / winter time changeover is not implemented. For correct execution, set the PLC clock as follows:

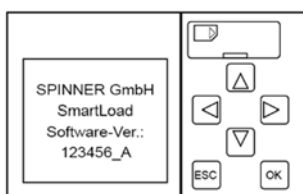

1) Press 3x Key ▼

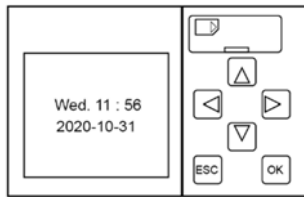

- 2) Press ESC.
- 3) Select "Setup" (Key ▼ or ▲) and press on OK.
- 4) Select "Clock" (Key ▼ or ▲) and press on OK.
- 5) Select "Set Clock" (Key ▼ or ▲) and press on OK.

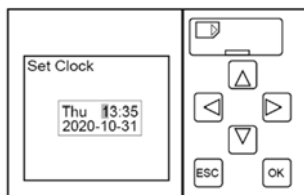

- 6) Move the cursor onto required position: Key ◀ or ▶.
- 7) Modify the value displayed with key ▼ or ▲. to set time and date
- 8) Confirm your entry by pressing OK.
- 9) Press 3 x ESC
- 10) Press 3x Key ▲

9.2 Deaeration of the cooling circuit



Before you start, ensure to read and understand the section safety messages and in particular chapter 1 "Safety" of this product manual. Observe the material data sheet of the coolant. Only qualified personnel may deaerate SPINNER dummy loads in accordance with the national safety and accident prevention regulations. Failure to observe could result in death or serious injury.



WARNING

Electric shock hazard

Electric shock can cause severe burns and fatal injuries.

Before you start ensure to disconnect your entire system from the power supply. Utilize appropriate devices and methods to prevent accidental energizing.



WARNING

Radio Frequency Hazard

Radio Frequency Power can cause burns, eye injuries and electrical shock.

Before you start ensure to disconnect your entire system from the power supply. Utilize appropriate devices and methods to prevent accidental energizing.



CAUTION

Hot surface

The resistor element heats up during normal operation and may cause burns.

Do not remove any covers shortly after use of the dummy load.

Do not touch the resistor element before cooled-down.



CAUTION

Poisoning Hazard

Skin or eye contact may cause irritation. Inhaling may irritate the respiratory organs.

Avoid skin or eye contact. Do not inhale gases, fumes and aerosols.

Observe the attached safety data sheet M36457 of the coolant.



Wear safety gloves



Wear eye protection

1. Check coolant level and refill coolant if required (refer to chapter 9.4)
2. Deaeration of complete system except the resistor element:
 - Wait until no more air bubbles appear in the expansion tank
 - Connect interlock and mains cables.
 - Turn on the power switch.

NOTICE Pump must not run dry

- Push the pump button S2 on the back of the control cabinet until no more air bubbles appear in the expansion tank.

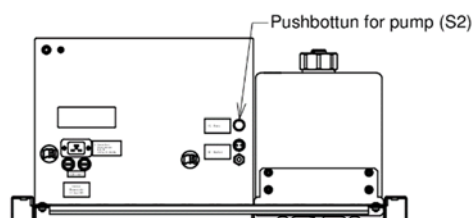

3. Deaeration of the resistor element

- Remove RF connector
- Open venting screw inside the inner conductor of the 3 1/8 "EIA connector until the seal is visible and air can escape.

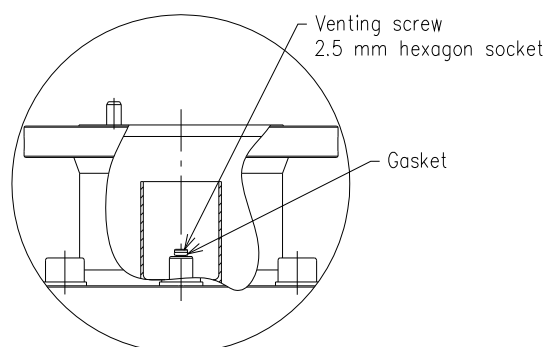

- Close venting screw until stop right after coolant escapes.
- Remove leaked coolant with suitable cloth.
- Reconnect RF connector.

NOTICE Faultless functioning of the dummy load can only be guaranteed, if the cooling system is deaerated properly. The coolant has to be clear and free of any bubbles.

9.3 Checking glycol concentration



Before you start, ensure to read and understand the section safety messages and in particular chapter 1 "Safety" of this product manual. Observe the material data sheet of the coolant. Only qualified personnel may check the glycol concentration of SPINNER dummy loads in accordance with the national safety and accident prevention regulations.

Failure to observe could result in death or serious injury.

WARNING

Electric shock hazard



Electric shock can cause severe burns and fatal injuries.

Before you start ensure to disconnect your entire system from the power supply. Utilize appropriate devices and methods to prevent accidental energizing.

WARNING

Radio Frequency Hazard



Radio Frequency Power can cause burns, eye injuries and electrical shock.

Before you start ensure to disconnect your entire system from the power supply. Utilize appropriate devices and methods to prevent accidental energizing.

CAUTION

Poisoning Hazard



Skin or eye contact may cause irritation. Inhaling may irritate the respiratory organs.

Avoid skin or eye contact. Do not inhale gases, fumes and aerosols.

Observe the attached safety data sheet M36457 of the coolant.



Wear safety gloves



Wear eye protection

Check for sufficient glycol concentration of the coolant at least annually.

Unscrew the cap of the coolant filling port.

- Measure glycol concentration with usual antifreeze testing device for ethylene glycol. The optimum glycol concentration is 39 % (equals antifreeze up to -24 °C).

Below 34 % glycol concentration (equals antifreeze up to -19 °C) Coolant needs to be replenished. Drain off excess coolant at the reservoir.

Above 44 % glycol concentration (equals antifreeze up to -29 °C) thin down coolant with distilled water. Drain off excess coolant at the reservoir.

Screw on cap of filling port.

9.4 Correcting the coolant level



Before you start, ensure to read and understand the section safety messages and in particular chapter 1 "Safety" of this product manual. Observe the material data sheet of the coolant. Only qualified personnel may correct the coolant level of SPINNER dummy loads in accordance with the national safety and accident prevention regulations.

Failure to observe could result in death or serious injury.

WARNING

Electric shock hazard



Electric shock can cause severe burns and fatal injuries.

Before you start ensure to disconnect your entire system from the power supply.

Utilize appropriate devices and methods to prevent accidental energizing.

Do not to spill any coolant into the housing of the dummy load.

WARNING

Radio Frequency Hazard



Radio Frequency Power can cause burns, eye injuries and electrical shock.

Before you start ensure to disconnect your entire system from the power supply.

Utilize appropriate devices and methods to prevent accidental energizing.

CAUTION

Poisoning Hazard



Skin or eye contact may cause irritation. Inhaling may irritate the respiratory organs.

Avoid skin or eye contact. Do not inhale gases, fumes and aerosols.

Observe the attached safety data sheet M36457 of the coolant.



Wear safety gloves



Wear eye protection

Refilling of coolant is necessary at coolant level below the marked minimum. The coolant level may exceed the marked maximum at temperatures above 25 °C.

NOTICE

If refill is required, use only coolant according to the specifications given in the attached data sheet.

Required coolant: SPINNER part number BN A74423 (30 litres canister)

Do not refill coolant via the drain hose or the hose connection.

Deaeration of the cooling circuit is mandatory after refilling (see chapter 9.2).

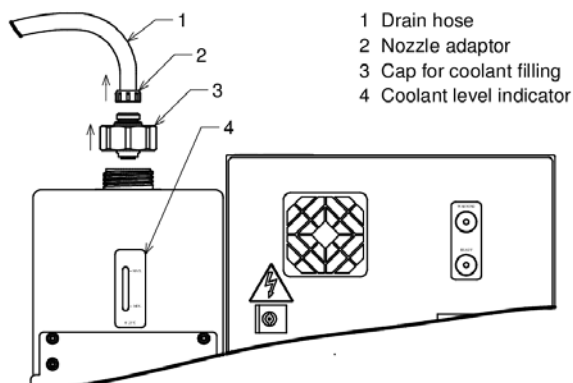

- 1 Drain hose
- 2 Nozzle adaptor
- 3 Cap for coolant filling
- 4 Coolant level indicator

To refill, remove the cap (3), if necessary, unscrew the nozzle adaptor (2) with drain hose (1) beforehand.

9.5 Front panel fan filter cleaning



WARNING

Electric shock hazard
Electric shock can cause severe burns and fatal injuries.
Do not use any liquids for cleaning.

If the filter blanket is saturated with dust, it can be vacuum cleaned or shook out and used again. To avoid a decrease in front panel fan performance, we recommend regular clean-ups, depending on the dust contamination in the environment.

10 Warranty

Do not disassemble the dummy load. The warranty is void, if the dummy load is modified, improperly handled or third party intervention or modification has occurred.

11 Repairs

Troubleshooting and repairs must be only carried out by qualified technical personnel or an instructed person under the direction and supervision of qualified personnel (refer to chapter 1.4 "Qualifications of personnel"). The safety instructions and in particular chapter 1. "Safety" of this product manual must be observed.



Do not open components to avoid the risk of electric shock and personal injury.

Electrically skilled persons may reset triggered motor protection switches integrated in the inverters or replace tripped mains fuses:

- If the motor protection of the inverter FU1 or FU2 has tripped: Turn off the main switch, wait about 30 seconds and then turn on power again.
- If the green indicator lamp "READY" does not lit although mains is connected and the main switch is turned on, check the mains inlet fuses. Unplug the mains connector at the back of the control cabinet to get access to the twin fuse tray. Pull out the tray and replace the tripped fuses size 5x 20 mm:

BN 546404C0200 250 V AC, 10 A T (time-lag)

BN 546404C0201 250 V AC, 16 A T (time-lag)

Electrically skilled persons may open the open the control box of the dummy load and check the SPS display:

- If no error was detected by the SPS, the white-backed display shows the software version, the operating time, the current temperatures or time and date. Press ▼ or ▲ to change screens.

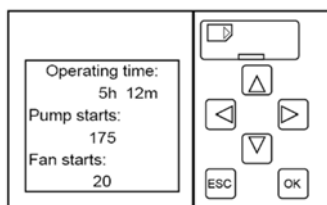

- If errors were detected by the SPS, the red-backed display additionally shows error messages. Contact SPINNER with a photos of all available screens and the type plate, refer to chapter 2.

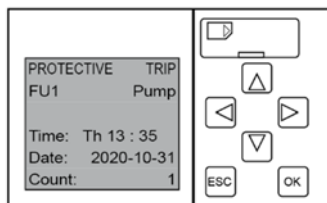

12 Demounting



Before you start, ensure to read and understand the section safety messages and in particular chapter 1 "Safety" of this product manual. Only electrically skilled persons may demount SPINNER dummy loads in accordance with the national safety and accident prevention regulations.

Failure to observe could result in death or serious injury.

WARNING



Electric shock hazard

Electric shock can cause severe burns and fatal injuries.

Before you start ensure to disconnect your entire system from the power supply.

Utilize appropriate devices and methods to prevent accidental energizing.

WARNING



Radio Frequency Hazard

Radio Frequency Power can cause burns, eye injuries and electrical shock.

Before you start ensure to disconnect your entire system from the power supply.

Utilize appropriate devices and methods to prevent accidental energizing.

CAUTION



Hot surface

The resistor element heats up during normal operation and may cause burns.

Do not remove any covers shortly after use of the dummy load.

Do not touch the resistor element before cooled-down.



WARNING

Crushing Hazard

Falling objects may cause death and serious injury.

The dummy load is heavy. Use suitable lifting gear and the lifting lugs of the dummy load only. The lifting gear must be approved to carry at least 150 kg.

Do not lift the dummy load at the RF connector.

Safety shoes are required. If it is necessary to stand below the dummy load during installation, safety shoes and hardhat are required.



Disconnect in the following order:

- Interlock loop connector
- Mains cable
- RF cable
- Separate PE conductor

13 Disposal



CAUTION

Poisoning Hazard

Skin or eye contact may cause irritation. Inhaling may irritate the respiratory organs. Avoid skin or eye contact. Do not inhale gases, fumes and aerosols. Observe the attached safety data sheet M36457 of the coolant.



Wear safety gloves



Wear eye protection

Empty the cooling circuit:

- Remove rear cover and pull off earthing cable on the shut-off valve side.
- Unscrew cap of filling port.
- Place a suitable collective vessel below pump or radiator.
- Open coolant drain screw to empty the cooling circuit.

NOTICE Residual quantities remain in the cooling circuit

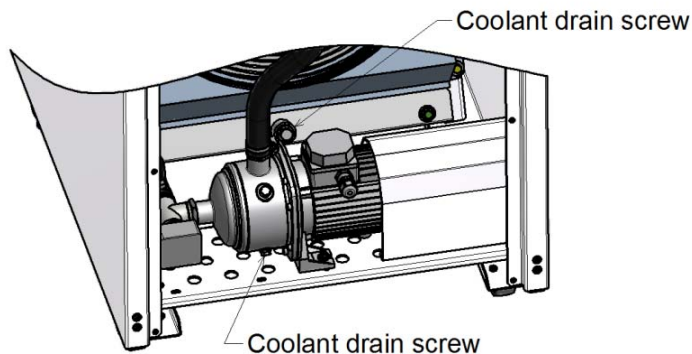

The user is responsible for disposing of the dummy load in accordance with the national waste disposal regulations. Improper disassembly or disposal may be hazardous.

Observe the material data sheet of the coolant.

Please contact SPINNER in advance, before returning the dummy load for disposal.

14 Spare Parts

Designation	Order-No.	Qty.
Power cord with IEC 60320-1 C19 socket	BN A77310	1
Interlock cable connector	BN 102964	1
Coolant 30 litres canister ANTIFROGEN N	BN A74423	1

15 Contacts

SPINNER GmbH • Headquarters

Erzgiessereistr. 33
80335 München

Germany

tel.: +49 89 12601-0
fax: +49 89 12601-1292
info@spinner-group.com
www.spinner-group.com

SPINNER Telecommunication Devices Co., Ltd.

351 Lian Yang Road
Songjiang Industrial Zone
Shanghai
201613 P.R. **China**

tel.: +86 21 577 45377
fax: +86 21 577 40962
info-china@spinner-group.com

16 Attachments

- EC Declaration of Conformity
- Data sheet 546404C0200-BE
- Environmental conditions TD-00060
- Circuit diagram 546404-CD-0E
- Factory acceptance test report
- Material safety data sheet of the ANTIFROGEN N coolant M36457

